

2121

June  
1985

# elektor **INDIA**

Rs. 7.50

# electronics

incorporating **selex**



**versatile**  
**timer • digitizer •**  
**multi purpose time**  
**switch • universal I/O**  
**bus for VIC64 •**  
**programmable**  
**array logic •**

*Sarvendra Singh*

**Now!**

**LUXCO**  
**SPEAKERS FOR:**

# COLOUR TV

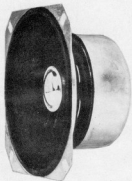

**10 LCT 5D**  
(4" Square)

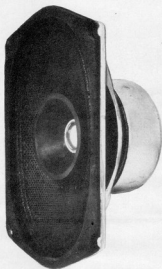

**10 x 15 LCT 6D**  
(4" x 6" Oval)

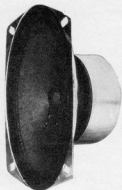

Suitable for Toshiba Kit.  
**8 x 13 LCT 3**  
(3 1/4" x 5" Oval)

**Speakers for B/W TV:** 10 x 15 LG 6 TV (4" x 6" Oval), 10 LG 5 TV (4" Square),  
7 x 10 LG 2 TV (2 1/2" x 4" Oval), 8 x 13 LG 5 TV (3 1/4" x 5" Oval),  
8 LG 1 TV (3 1/4" square) For Portable TV.

The LUXCO Range also covers speakers for:



Transistors, Tape recorders, Stereo systems,  
Car Stereos, Intercoms and P.A. systems.

Manufactured by:  
**LUXCO Electronics**  
Allahabad—211 003

Sole Selling Agents:  
**LUXMI & CO.**

56, Johnstonganj  
Allahabad—211 003.  
Phon. 11, Telex: 540-286

**LUXMI & CO.** Delhi & Haryana:  
**LUXMI & CO. Electronics**

Radic Place, Chandni Chowk  
Delhi-110 006.  
Phone: 239944, 233187.

Distributors for Maharashtra,  
Gujarat and South India:

**precious**<sup>®</sup>  
Electronics Corporation

- Chotani Building, 52, Proctor Road,  
Grant Road (East), Bombay-400 007.  
Phones: 367459, 369478
- 9, Athipattan, Street, Mount Road,  
Madras—600 002, Phone: 842718.

Wanted stockists all over India

**sound technology from a sound source**

# elektor contents

Volume 3-Number 6

EDITOR: SURENDRA IYER  
 PUBLISHER: C. R. CHANDARANA  
 PRODUCTION: C. N. MITHAGARI

ADVERTISING & SUBSCRIPTIONS

elektor electronics pvt ltd.  
 Chotani Building  
 52 C, Proctor Road Grant Road (E)  
 Bombay-400 007.

DISTRIBUTORS: INDIA BOOK HOUSE

PRINTED AT:  
 TRUPTI OFFSET  
 103, Vasan Udyog Bhavan,  
 Off Tulsi Pipe Road,  
 Lower Parel, BOMBAY-400 013.

Elektor India is published monthly under agreement with Elektuur B.V. Holland. August/September is a double issue.

SUBSCRIPTION

INLAND  
 1 Yr Rs. 75/- 2 Yrs Rs. 140/- 3 Yrs Rs. 200/-  
 FOREIGN  
 One year Only  
 Surface mail Rs. 125/- Air mail Rs. 210/-

The Circuits are for domestic use only. The submission of designs of articles to Elektor India implies permission to the publishers to alter and translate the text and design, and to use the contents in other Elektor publications and activities. The publishers cannot guarantee to return any material submitted to them. All drawings, photographs, printed circuit boards and articles published in Elektor India are copyright and may not be reproduced or imitated in whole or part without prior written permission of the publishers.

Patent protection may exist in respect of circuits, devices, components etc. described in this magazine.  
 The publishers do not accept responsibility for failing to identify such patent or other protection.

INTERNATIONAL EDITIONS EDITOR: P. HOLMES

- Dutch edition: Elektuur b.v.  
6190 AB Beek (L),  
the Netherlands
- German edition: Elektor Verlag GmbH,  
51333 Gangelt, W-Germany.
- English edition: Elektor/Publishers Ltd.  
Elektor House, 10 Longport,  
Canterbury CT1 1PE, Kent, U.K.
- French edition: Elektor Sari, Le Seau,  
59270 Basilleul, France
- Italian edition: Elektor, 20092 Cinisello B., Italy.
- Spanish edition: Elektor, Av. Alfonso XIII,  
141, Madrid 16.
- Greek edition: Elektor, Karaiskaki 14, Voula,  
Athens.
- Turkish edition: Elektor Yayincilik ve Ticaret A.S.,  
Karakoy Istanbul
- Portuguese edition: Ferreira and Bento Lda  
R.D. Estefania 32, 1000 Lisboa  
Portugal.

COPYRIGHT © ELEKTUUR B.V. —  
 THE NETHERLANDS 1984

news, views, people .....	6-12
selektor .....	6-14
Shining a light on new technology	
A/D and D/A conversion .....	6-16
A fresh look at the state of the art.	
programmable timer .....	6-20
A truly versatile timer/calendar with a host of facilities.	
universal I/O bus .....	6-29
Primarily intended for the Commodore 64, this bus can also be used with many other computers.	
an IBM compatible micro .....	6-34
In this short introduction, we explain the intent of the project which will be published next month.	
panorama mixer .....	6-35
A four-channel mixer that enables you to position a sound anywhere in the audio spectrum.	
digitizer .....	6-36
This unit provides the staple diet for your computer from all sorts of (analogue) inputs.	
programmable array logic .....	6-40
This modern technology deserves to be better known to all electronics designers.	
L.C.D. thermometer .....	6-48
We present a digital circuit, which is inexpensive, accurate, precise, and has a very low power consumption. The range of the instrument is such that it is suitable for practically any application.	
temperature-to-voltage converter .....	6-52
multi purpose time switch .....	6-52
reading-in-bed limiter .....	6-54
market .....	6-64
switchboard .....	6-69
missing link .....	6-74
index of advertisers .....	6-74



digilex .....	6-56
digi-course (chapter-2) .....	6-58
voltage, frequency, current .....	6-61

Components for microprocessor based projects are available with:  
 M/s DYNALOG MICRO-SYSTEMS 14, Hanuman Terrace,  
 Tara Temple Lane, Lamington Road, Bombay 400 007.



# VU METERS

## FOR EVERY APPLICATION

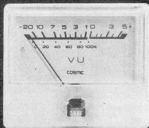
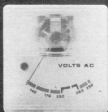

### STOCKISTS

Western Region :  
**Precious Electronics Corporation.**  
 Chhotani Building, 52-C, Proctor Road,  
 Grant Road (East), Bombay - 400 007  
 Phones : 367459, 369478

Southern Region :  
**Precious Electronics Corporation.**  
 9, Athipattan Street, Mount Road,  
 Madras - 600 002. Phone : 842718

Northern Region :  
**Tantia Electronics Co.**  
 422, Lajpat Rai Market,  
 Chandani Chowk, Delhi - 110 006  
 Phones : 238612, 233856

Manufactured by :  
**Padma Electronics Pvt. Ltd., Tamil Nadu**

**INTRODUCING**

**ION**  
**MINIATURE  
 SOLID STATE  
 ELECTRONIC  
 BUZZER**

Actual Size

- Extraordinary Audio Penetration
- Frequency: 4.6 (± 0.5) KHz
- Low Power Consumption
- 10 mA at 12 vdc
- Wide Operating Voltage
- Works on 1.5 to 27 Volts DC
- C-MOS Compatibility: Control Wire Draws Less than 100 µA
- Compact Rugged Construction
- Assured Delivery

MODEL: IPB 27  
 PRICE (100 and ABOVE)  
 Rs. 18/- EACH  
 Local Taxes Extra

Also available: Bigger Buzzers  
 MODEL: IPB 35 2.8 KHz Rs 23/-  
 2 IPB 35: Interrupted Buzzer Rs. 27/-

**APPLICATIONS: INTERPHONES, ALARM CLOCKS, TIMERS, COMPUTERS, TV GAMES, TOYS, MEDICAL EQUIPMENTS**

**ION  
 Electricals**

307 Owner's Industrial Premises  
 505 Gabriel Road Mahim  
 Bombay 400016 (India)  
 Phone: 46 8157 Gram Temptime

**YOUR DEPENDABLE SOURCE . . .**

**TEXONIC INSTRUMENTS**

<b>EE ELECTRONICS CORPORATION OF INDIA LIMITED</b> GENERAL SAISON DIODES POWER TRANSISTORS ETC.	<b>MELTRON</b> SEMICONDUCTOR PRODUCTS	<b>MELTRON</b> ELECTROLYTIC CAPACITORS
<b>CTR MANUFACTURING INDUSTRIES LTD.</b> METALLIZED POLYESTER FILM ELECTROLYTIC CAPACITORS COMPENSATION CAPACITORS	<b>PROTECTION</b> TEMPERATURE APPROVED GLASS CAPACITORS RESISTORS & TIME DELAY DEVICES THERMAL PROTECTORS 1/8W CAPACITORS AND CONNECTORS ETC.	<b>COMPONENTS INDIA</b> TRANSISTORS SWITCHES ICs SPECIAL REQUIREMENT LEADS
<b>PARAMOUNT INDUSTRIES</b> ELECTROMAGNETIC RELAYS 5.6 (6 AMP) ENCLOSED TYP 25-10 25 AMP POWER RELAYS 1/2 INCH	<b>ALCON ELECTRONICS</b> ELECTROLYTIC CAPACITORS	<b>EC</b> TERMINAL SINGLE FILE HOUSING LEAD HOLDERS CONNECTORS WIRE PRODUCTS
<b>MENTAL ENGINEERING ENTERPRISES</b> PROFESSIONAL GRADE PUSH BUTTON SWITCH	<b>MINI-SAN</b> CONNECTORS (TV KIT)	<b>Afcosec AFCO LTD</b> HEAT SINKS MOUNTING ACCESSORIES ETC.

**TEXONIC INSTRUMENTS**

Our Most Important Component - SERVICE

2 HANDESHAPPA LANE  
 5/F, ROAD CROSS  
 BANGALORE-560 002  
 PH: 84440N/848112 PH: 224620/224628

# STOP!

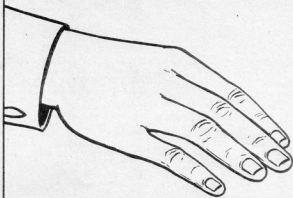

## BEFORE YOU BUY

### A $\mu$ P Training / Development Kit

Make sure  
you are getting  
all that you need.

## MICROFRIEND

Series gives you all that you need

- Powerful hardware and software features to meet all your requirements.
- Most comprehensive, easy to understand courseware documentation. Complete with data sheets of ICs used.
- Instant service back up from expert engineers.

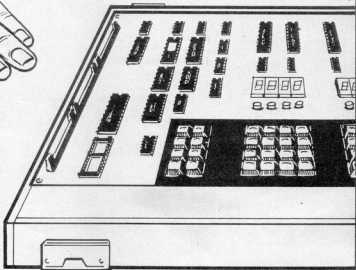

**MICROFRIEND-I:** 8085 CPU, 4K Firmware, 2K RAM, Expandable to 24K ROM or 12K RAM, EPROM Programmer for 2716, 2732 and 48016, 46 PIO lines, TTY-20 mA, RS232C I/F, Audio cassette I/F, 8155 Timer, 6 digit display and keypad, STD Bus for expansion.

**MICROFRIEND-Z:** Z80 A CPU with specifications same as Microfriend-I.

**MICROFRIEND-68:** 6802 CPU with specifications same as Microfriend-I.

**MICROFRIEND-II:** 8085 A CPU, 4K Firmware, 2K RAM, Expandable to 24K ROM or 12K RAM, 48 PIO lines, TTY-20 mA, RS232C I/F, Audio cassette I/F, 8253 Timer, 6 digit display and keypad, 50 Pin buffered Bus for expansion.

**MICROFRIEND-III:** 8085 A CPU, 8K Firmware with Editor Assembler, 2K RAM, Expandable to 52K RAM or ROM, EPROM Programmer for 2716, 2732, 2764, 27128 and 27256, 48 PIO lines, 80 x 24 Video Controller using MC 6845, ASCII Keyboard I/F, Centronics Printer and Audio cassette I/F, RS232C I/F using 8251, 8253 Timer, 32 Key Keypad and 6 digit display, STD Bus for expansion.

**MICROFRIEND-ZLC:** Z80 A CPU, 4K Firmware, 2K RAM, Expandable to 8K ROM or RAM, 16 PIO lines, Audio cassette and Serial I/F, EPROM Programmer for 2716 to 27128, Z80 CTC Timer, 6 digit display and keypad.

**MICROFRIEND-65:** 6502 CPU, 4K Firmware, 2K CMOS RAM, 64K DRAM, Memory expandable to additional 16K, EPROM Programmer for 2716 to 27128, RS232C Serial I/F, Audio cassette I/F, 8253 Timer, 6 digit display and keypad, STD Bus for expansion.

**MICROFRIEND-86:** 8086 CPU, 16K Firmware, 4K RAM, Expandable to 48K RAM or ROM, 128K DRAM, EPROM Programmer for 2716 to 27128, RS232C Serial I/F, Audio cassette I/F, 8253 Timer, 8 digit display and keypad, MULTIBUS for expansion.

**MICROFRIEND-8678:** 8086 CPU, Socket for optional 8087 and 8088 CPU, 16K Firmware, 4K RAM, Expandable to 48K RAM, or ROM, EPROM Programmer for 2716 to 27128, 72 PIO lines, RS232C Serial I/F, Audio cassette I/F, 8253 Timer, 8 digit display and keypad, 50 Pin Buffered Bus for expansion.

**MICROFRIEND-68K:** 68000 CPU, 20K Firmware, Single line Assembler and Disassembler, 32K DRAM, Expandable to 256K, EPROM Programmer for 2716 to 27128, 80 x 24 Video Controller using MC 6845, RS232C Serial port with complete baud rate control, Centronics compatible printer port plus one more PIO port, Audio cassette I/F, ASCII keyboard I/F.

**PLUS A WIDE RANGE OF OPTIONAL ATTACHMENTS TO EXPAND THE SYSTEM.**

Manufactured by:



## Dynalog Micro-Systems

14, Hanuman Terrace, Tara Temple Lane,  
Lamington Road, Bombay 400 007

Tel: 353029, 362421,  
Telex: 011-75614  
Gram: ELMADEVICE

North Zone Rep.:

TECHNICS  
4731/21 Dayanand Marg, Daryaganj,  
New Delhi 110 002  
Tel: 276988, 270832

Setting the standards in  $\mu$ P based technology.

ektor india june 1985 6.05

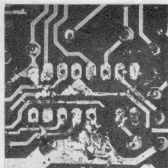

←  
**Desoldered  
Without  
Diamond**

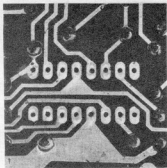

←  
**Desoldered  
With  
Diamond**

# Diamond Desoldering Pump

- Desolders thoroughly.
- Sturdy construction
- Replaceable Teflon Nozzle
- Largest selling in India
- Widely accepted in U.K., U.S.A., West Germany and Singapore.

**Export Enquiries Welcome**

Distributors:

**precious<sup>®</sup>** Electronics Corporation

Chhotani Building 52C, Proctor Road Grant Road (E), Bombay-400 007.

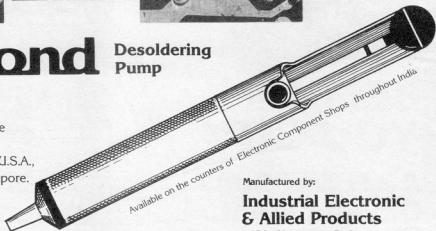

Manufactured by:

**Industrial Electronic  
& Allied Products**

1423, Shukrawar Peth,  
Off. Bajirao Road,  
POONA 411 002, India.

Phone: 446241, Gram: SEFOTAKE.

## AVAILABLE EX-STOCK

### COMPONENTS:

- QUARTZ CRYSTALS TEXTPOOL
- ZIF SOCKETS • NATIONAL CONDENSOR
- MICROPHONES, • DIP SWITCHES
- KEY BOARD SWITCHES

### TOOLS & TESTING METER:

- AC OPERATED MINI HAND DRILL FOR PCB DRILLING • IC INSERTION TOOLS
- DIGITAL MULTIMETERS • DIGITAL TACHOMETERS • DIGITAL IC TESTER

### ALSO AVAILABLE:

- EPSON-GX-10 COMPUTER
- COMPUTERS SYSTEM

CONTACT:

**KAYTEE  
ENTERPRISE**

318, PAREKH MARKET, 39, KENNEDY BRIDGE  
BOMBAY - 400 004 PHONE - 356271 380375

**The  
Widest  
Choice in  
Connectors!**

What's the best possible way to please everyone? By offering a variety of products sure to meet every customer's needs. That's what we at CONNECTRONICS have done. The connectors shown above are just a few of the high quality products we offer. Variety and quality - that's what makes CONNECTRONICS customers keep coming back.

*Connectronics*

Chhotani Building, Shop No. 2D, Ground Floor,  
Proctor Road, Bombay 400 007  
Phones: 360709, 384123

SIEMENS

# SIMAT

## Programmable

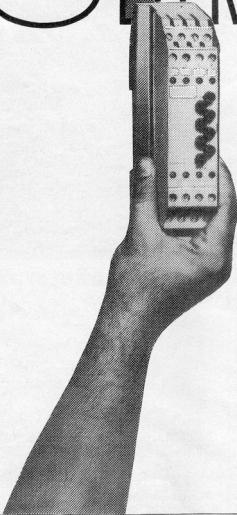

The SIMATIC series of Programmable Controllers (PCs) is the very latest technology in automation. Throughout India they are rapidly replacing old contactors and relays and hard-wired electronic control systems.

### Unparalleled flexibility, Unmatched power

The SIMATIC range of Programmable Controllers — 110A, 110S and 150K — now manufactured by Siemens India, offer both low and high functional capabilities that not only increase reliability and accuracy, but also permit fault diagnosis, computation and data handling facility in addition to simple closed-loop controls.

The expansion capability, graded performance and structured programming of SIMATIC PCs make it possible for them to automate anything from a single machine to an entire manufacturing process.

New Development from  
Siemens India

# IC PC

## Controllers

### Reliable hardware, Proven software

Every SIMATIC PC is precision-engineered to live upto Siemens' reputation for rugged construction. All input/output modules are encapsulated to protect the electronic components from damage and against environmental conditions. Protection is also ensured against contact with live parts. That's why SIMATIC PCs have an operational life of many years.

SIMATIC PCs also offer you the largest library of tried and tested application software.

Programmes are available in standardized function blocks for quick and easy programming, commissioning and de-bugging.

Only Siemens India offers such perfect hardware — software compatibility.

### Tried and tested in Indian Industry

From major industries like Tata Steel and Satna Cement to small scale manufacturers of machinery, the SIMATIC series of programmable controllers have repeatedly proven the simplest, most efficient route to automation.

### Programming Facilities

SIMATIC PCs accept programmes not only in ladder diagram but also in logic diagrams and statement lists.

The highly versatile Siemens PU 675 programming unit is available for quick and easy programming. Siemens also trains users in programming techniques.

If you'd like to learn more about how SIMATIC PCs could meet your specific requirements, please write to:-

**Siemens India Ltd.,**  
134-Dr. Annie Besant Road,  
Bombay 400 025.

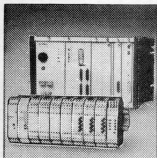

SIMATIC PCs 110A & 110S

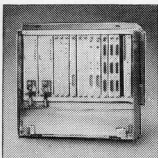

SIMATIC PC 150K

## The automatic choice for automation





## KEIL Plastic Film Capacitors in Box configuration.

A complete package for entertainment and professional electronics.

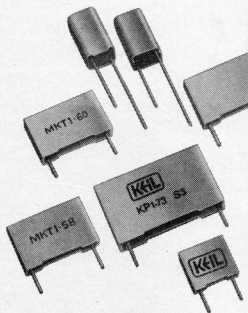

**Kothari Electronics & Industries Ltd.**

"Kothari Buildings"  
114, Nungambakkam High Road  
Madras 600 034, INDIA

**KEIL Capacitors—a generation ahead of others in technology.**

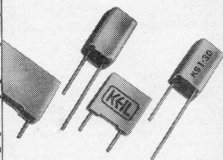
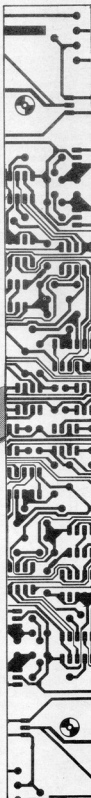

## For your unique circuit needs KEIL has the answers.

In collaboration with world renowned Plessey Italia (now ARCOTRONICS ITALIA S.p.A) KEIL produces a complete range of plastic film capacitors to satisfy the specific needs of Black & White—Colour TVs; telecommunication equipment, Power Electronics, analog Digital systems etc.

### Metallised Polyester/Polypropylene Capacitors

Produced to IEC standards using latest state-of-the-art automated machines, Miniature, radial lead Metallised Polyester/Polypropylene capacitors, in wide varieties, offer excellent choice to designers for selection of the right capacitors for specific functions. Ultra modern spraying and welding facility together with box encapsulation ensure excellent electrical, mechanical and environmental characteristics for reliable long term performance.

#### Metallised Polyester Capacitors

MKT 1.56	0.010 $\mu$ F — 1 $\mu$ F	250V—400V
MKT 1.60	1000 pF — 6.8 $\mu$ F	100V—1000V
MKT 1.58X	0.01 $\mu$ F — 0.47 $\mu$ F	250VAC
MKT 1.67	1000 pF — 0.33 $\mu$ F	100V—630V

#### Polypropylene capacitors

MKP 1.71	1000 pF — 3.3 $\mu$ F	160V—630V
KP 1.73	1000 pF — 0.22 $\mu$ F	630V—2000V
MKP 1.76	0.01 $\mu$ F — 1 $\mu$ F	250V—400V

### Precision Grade Polystyrene Capacitors

Made to E 192 series as per IEC specification upto a close tolerance of  $\pm 0.5\%$ , with very high reliability and stability factor. Made specially for telecommunications and other precision circuit requirements.

KS 1.16	47 pF — 603000 pF	63V—1000V
KS 1.30	47 pF — 34000 pF	63V
KS 1.39	47 pF — 603000 pF	63V—1000V
KS 2.34	47 pF — 220000 pF	100V—500V
KS 2.31	10 pF — 100 pF	150V

**We have a full fledged application support group, which will help you to select the ideal capacitor. Please write to us.**

## Shining a light on new technology

The information revolution of the past few years has quickly turned the disciplines of electro-optical components and optical systems into multimillion pound businesses.

New uses for light based systems are continually being found in areas such as medicine, telecommunications, image processing, process industry analysis, remote sensing, and product testing and measurement.

Among the more exotic uses are applications in the emerging generations of robots and airborne missiles that can alter their behaviour or their course in response to what they 'see' around them. They do this by rapid computer analysis of incoming information about their environment, followed by almost instantaneous new commands to their drives and guidance systems.

In telecommunications, British Telecom is now replacing large sections of Britain's trunk network with optical fibre lines. These hair-thin strands of glass can simultaneously carry — in digital format — voice

data, computer data, pictures, and facsimile.

### Laser power

And, perhaps most exciting of all, medical specialists are beginning to use light in the form of lasers for regular high precision microsurgery.

Electro-optics in many forms is an area in which British research and development have blossomed — particularly in laser technology. Following research by scientists at the United Kingdom Atomic Energy Authority research laboratories at Harwell, for instance, equipment is now commercially available for accurately measuring the composition and temperature of gases inside chemical reactors.

The technique involves extracting a small sample of the gas from the reactor and passing through it the light from three laser beams. The resulting light beam from the three lasers intersecting at the sample is analysed to determine gas composition and temperature up to about 5000 K with a 1 to 2 per cent error, according to Harwell.

The coherent Stokes Raman scattering technique is the result of more than three years' research financed by the Department of Trade and Industry. Hardware and software for the system are available from Epsilon Research of Rugby.

### Beams and dye

The major benefit of this laser system over methods used to date is the non-invasive nature of the beams. As the lasers do not disturb the reactor environment, with the sample typically taken by adding a small cylindrical extension with windows to the reactor, the analysis results are more accurate than intrusive methods.

The Epsilon system is based on a neodymium-doped yttrium aluminium garnet (YAG) laser which produces infrared pulses converted into green light. Two-thirds of the light is split into two parallel beams and focused on the gas sample, together with the remaining third, which has been passed through a dye to change its colour.

The colour of the resulting light depends on the dye used in the systems, which is chosen to suit the gas being analysed.

Electro-optics can provide equivalent accuracies for more established engineering problems such as alignment of rotating shafts, with lasers now being adopted to check both angularity and parallelism of shafts used in equipment such as high speed turbo-generators.

INA Bearing of Sutton Coldfield, has just introduced such an alignment system called Optalign. This is said to allow rapid and extremely precise alignment, with a resolution of as little as  $1\ \mu\text{m}$  in both vertical and horizontal planes. And as there is no 'sag' in the laser beam, the system can be used for very long span alignment of so-called jack shaft assemblies.

### Four components

Under normal circumstances, deter-

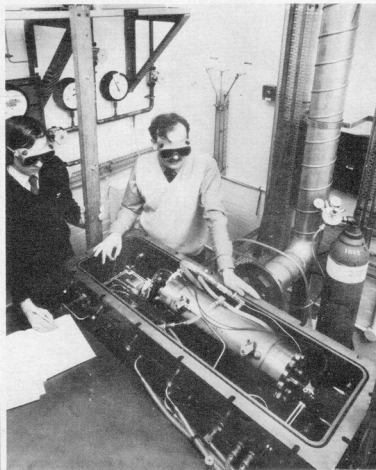

Harwell scientists work on a non-intrusive laser system that is now available from Epsilon Research for analysis of conditions inside chemical reactors.

mining the magnitude of the two main alignment parameters — parallel offset and angular misalignment — is complex and time consuming, requiring repetitive checks with dial test indicators and feeler gauges after each attempt at alignment. INA says that Optalign overcomes these problems.

Optalign comprises four main components. They are a low power laser and receiver unit, a reflector prism, a hand-held beam finder, and a microprocessor with special software and a graphic display device for alignment data.

With supplied brackets and clamps, the laser unit is fitted to one of the shafts to be aligned and the reflector prism is clamped to the other shaft. The brackets have integral, sensitive spirit levels set mutually perpendicular.

The technique is based on the fact that when the shafts are aligned, the distances measured between two planes perpendicular to the axial planes of the shafts are the same at positions 90 degrees around the shafts.

#### Engineering applications

Once the beam sensor has been used with the computer control to produce coordinate datum positions, the shafts are rotated through 90 degree increments and misalignment readings are automatically taken by pressing a key. The display then shows the corrective alignment action needed.

Photo-electric controls of several forms are also becoming widely used in engineering, typically for 'sensing' what is happening inside a machine or process. Installing such photo-electric systems in either confined or dirty spaces can cause problems, however.

By designing a photo-electric control with an optical fibre lead, Cambridge based Visolux is helping to overcome the difficulties of tight or inaccessible mountings.

Visolux's KSU-LL is direct current operated and for use with LC series optical fibres, using a gallium-arsenide light emitting diode to transmit the modulated light along the lead. Flexible, with an optimum length of 1 m, the lead facilitates the siting of a small detection point in positions where it would be impossible to fit a conventional photo-electric control, according to Visolux.

#### Sensitivity device

A quick action release on the control unit allows the user to convert the optical fibre lead between a single

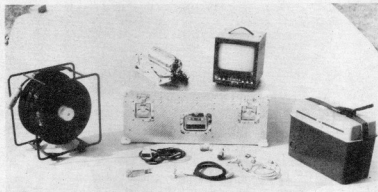

path light switch mode and a reflection light scanner function.

The company says an important part of the system is that the sensing distance can be varied with a sensitivity device. This means that the scanner range can be reduced — for example, to avoid picking up interference from background materials. The demand for data collection and transmission through optical media has given a major boost to the optical fibre industry.

With new customers seeking the finest possible tolerances on fibre to minimize losses in data transmission, the industry has had to raise quality levels.

The successful handling, splicing, and operation of optical fibres depends on the maintenance of fixed values for overall diameter, core diameter, ellipticity, and concentricity. From Vickers Instruments, based at York, comes a complete system for monitoring fibre geometries, called Fibercheck.

#### Measurement of fibre connectors

The system comprises light generating equipment, a range of lenses and filters, micrometer and numerical aperture adjustment equipment, and a video system with related image manipulation and measurement controls.

By comparing images of fibres, the physical parameters of the samples can be determined. As well as handling monomode and multimode fibres, Fibercheck can measure the end face geometry of optical fibre connectors. An intensity profile display can be set to measure between zero and 100 per cent intensity to accommodate varying industry standards.

Fibercheck uses direct physical measurement techniques rather than computer processing of a video signal. Vickers says measurement settings are made with a television monitor which gives a clear picture of

Insight Vision Systems' compact Vidicon system for maintenance work on sewers and pipework.

a fibre or ferrule end. With a little training, operators can learn to make rapid, precise measurements.

Such is the sophistication of latest closed circuit television systems that they can be used to provide information leading to substantial savings made possible by preventive and speedy maintenance.

#### Tiny television camera

A typical system from Insight Vision Systems of Malvern, is the 75 series aimed at water authorities, local government, and maintenance engineers charged with responsibility for drains, sewers, and water mains. The system is based on a miniature television camera, which is fed along pipelines to give a picture on a control console on the surface. The lighting and control system is claimed by Insight to be an innovative design giving optimum illumination of pipelines.

The control console is based on a 225 mm television monitor and controls all camera functions, including focus, near and far lighting, and manual and automatic iris. Plug-on attachments available for the camera can also be operated from the console.

The camera has 600 lines of picture height with a Vidicon tube providing various options. The lens is a 12.5 to 75 mm, f1.8 zoom, and the camera weighs less than 800 g. It consumes less than 2 W of power.

V Wyman (asst editor *The Engineer*) (LPS)

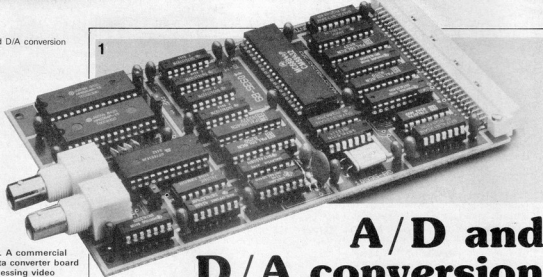

Figure 1. A commercial 8-bit data converter board for processing video signals.

An analogue-to-digital converter is also referred to as an encoder, as a digitizer, or as a quantizer.

A digital-to-analogue converter is often called a monolithic D/A converter and is also known as a decoder.

a review of the state of the art

Figure 2. Simple data processing system. Note that the analogue data are also electrical signals.

All computers, except analogue types, work with digital signals. Unfortunately, most information that needs to be processed in computers is of a continuously varying (= analogue) character: pressure; temperature; speed; acceleration; luminous flux; frequency; voltage; and many more. Before such information can be processed by the computer, it has to be translated into binary digits (=bits). Once the information has been processed, the digital output of the computer must often be converted into analogue signals. These analogue-to-digital (A/D) and digital-to-analogue (D/A) conversions are accomplished by special ICs, which are normally located in the computer system as input ports (A/D) or output ports (D/A). This article aims at showing what all this involves and the state of the art.

The data book of a major semiconductor manufacturer states in its introduction: "This book gives 34 types of A/D converter circuits; if none of these meets with your requirements, there are 92 further types available. Information on these will be supplied upon request". The main differences between all these types lie in circuit techniques, application, and packaging. This last aspect will not be dealt with in this article, because it hardly affects the designer.

## Data processing

As an example of what is involved in the

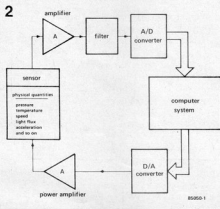

dual conversion process, let us consider the simple data processing system shown in figure 1, and let us assume that the sensor is the object lens of an electronic camera. The amount of light captured by the lens is translated in the camera into continuously varying electrical signals, which are amplified, filtered, and then converted into digital signals. The computer stores and processes the information and, based on this, generates a digital signal that is converted into an analogue signal, which, after amplification, is used to focus the object lens.

## Analogue-to-digital converter

Semiconductor manufacturers proudly emphasize the 'speed' of their particular product. But what does a '100 MHz conversion rate' or a '100 ns conversion time' really mean? What criteria should we consider in these converter circuits? In our opinion, the following are of prime importance.

- Detailed information as to the input and output signals (range of analogue signals; source and load impedances; binary coding; logic levels).
- Conversion rate (this is not the reciprocal of the conversion time).
- Information on the control interfaces.
- Permissible error rate.
- Effect of external factors (particularly temperature) on the accuracy.

Additionally, the following should also be known.

- Range, resolution, and filtering of the input signal.
- Permissible non-linearity.
- Required stability of the supply voltage(s).

Quite a number of characteristics to look at! So, let us look at the various conversion techniques, their pros and cons, and on that basis formulate possible applications. First, the dual slope technique, well known for its use in digital voltmeter applications. In this technique, the conversion cycle consists of two basic time periods. Period  $t_1$  results from the integration during a given time interval of the input voltage: the output voltage,  $U_o$ , of the integrator is directly proportional to the input voltage,  $U_i$ . At the end of period  $t_1$ , a reference voltage,  $U_r$ , is applied to the integrator, so that  $U_o$  decreases. The integration continues until  $U_o$  reaches the zero reference level. The time taken by  $U_o$  to do this,  $t_2$ , is the down ramp period. Period  $t_1$  is constant for each conversion time, while  $t_2$  depends on  $U_i$ . After integration, it is found that

$$U_i = U_r t_2 / t_1$$

If, therefore,  $t_1$  and  $t_2$  are measured, and  $U_r$  is accurately known, the level of the analogue input voltage can be determined.

The advantages of circuits using this technique are: inherent accuracy; excellent noise suppression, no need for latches; no need for high stability or low tolerance external components; coding errors cannot occur; and last, but not least, low cost. The principal drawback is the low conversion rate: 3...100 conversions per second. In digital voltmeter applications all the advantages count, while the drawback does not matter at all.

The second conversion method is based on successive approximation. This (serial) technique is not as fast as some others, but its low cost, ease of construction, and system operational features make it the most widely used method in use today. The successive approximation system uses a digital-to-analogue converter in a feedback loop, and, in operation, compares the bits of this converter one at a time, starting with the most significant bit (MSB). As each bit is compared, the output of the comparator indicates whether the analogue input is smaller or greater than the output of the D/A converter. After all the bits of the D/A converter have been tried, the conversion cycle is complete, and another is started. A description of the practical use of this system can be found in *digitizer* elsewhere in this issue. The principal advantage of this system is its relatively high speed of some  $10^5$  conversions per second. Its drawbacks are the need for high stability external components; coding errors are possible; latches are required; automatic zero setting is difficult; higher cost. However, these disadvantages are negated to a large extent by constructing the A/D con-

verter on the same chip as the sample-and-hold amplifier, the reference voltage sources; circuits for automatic zero setting, and so on.

The third system, which has only come to the fore in the last year or so, is called parallel or flash encoding. This method requires  $2^n - 1$  comparators for  $n$  bits of information. Because so many comparators are required, it was not until recent advances in the state of the art of ICs that all of these could be accommodated on one chip. A typical example of an encoder based on this technique is illustrated in figure 1 (in which only one of the ICs is the A/D converter, of course). The interface board shown is primarily used in meteorological radar equipment and in robotics. Appropriate graphics processors are available. Its data acquisition rate lies at 5 MHz; the resolution is 8 bits; and the conversion time is 200 ns. A similar interface, containing a DMA (direct memory access) control circuit, is compatible with the bus for the 6809 and 68008 processors.

Details of the A/D converter IC used in figure 1 are shown in figure 3. The input

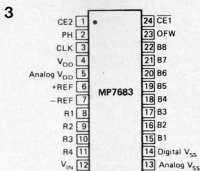
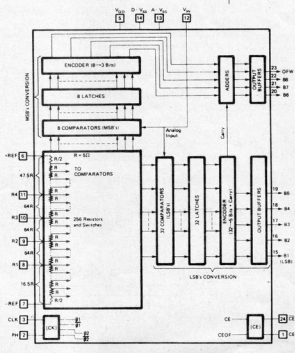

Figure 3. Block diagram and pinout of a parallel or flash converter.



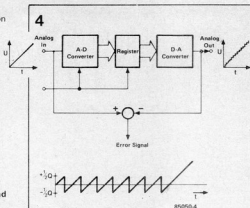
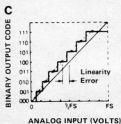
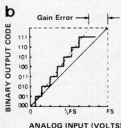
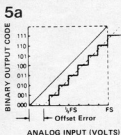

Figure 4. Encoding and decoding (a) lead inevitably to quantization errors (b).

Figure 6. Illustrating a differential linearity error of  $\pm \text{LSB}/2$ . When the error is negated, each conversion stage has an output of exactly  $Q$ .

Figure 5. In a practical A/D converter, offset errors (a), gain errors (b), and linearity errors (c) occur. Their combined effects result in a quantization error.



signal at pin 12 is converted in two stages. The first stage, consisting of eight comparators, eight latches, an encoder, and four output buffers, generates the three most significant bits (MSBs). The five least significant bits (LSBs) are produced by the second stage which comprises thirty-two comparators, thirty-two latches, an encoder, and five output buffers. Power dissipation in this two-stage arrangement is smaller than in single conversion. From a circuit design point of view, the flash encoder IC provides, of course, single D/A conversion.

The reference voltage for the 256 resistors and forty switching stages is applied between pins 6 and 7. The voltage take-off points are connected to the inverting inputs of the forty comparators.

Then there are four control inputs: CLK (clock); PH (clock polarity);  $\overline{CE}_1$  (when this terminal is logic 1, B1...B8 provide a three-state output); and  $\overline{CE}_2$  (when this terminal is logic 0, B1...B8 and the OFW buffer — pin 23 — provide a three-state output).

The OFW output may be used as a ninth bit when two of these ICs are cascaded. As an example, when the input voltage is 2.56 V, and the reference voltage is 5.12 V, the output code is 10 000 000. A complete conversion cycle takes place during one clock pulse.

The attraction of this technique is, of course, the very high conversion rate of 5 MHz. Its drawback remains that a converter still uses more circuits, and therefore space, than a converter using the other two techniques.

### Quantization error

This is a fundamental error associated with dividing a continuously varying (analogue) signal into a finite number of

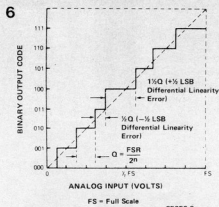

bits; its maximum value is  $\pm Q/2$  (where  $Q = \text{LSB}$ ).

As an example, figure 4 shows in schematic form the conversion of a ramp signal from analogue to digital and back again to analogue. When the output signal of the decoder is deducted from the original signal, or vice versa, there is an error signal, which may be considered as the r.m.s. output of a noise generator,  $U_q = Q/\sqrt{12}$ , superimposed on the input signal. Because of that, the effect is also sometimes called quantization noise.

This property is, of course, of particular interest in the selection of A/D or D/A converter ICs for use in PCM (pulse code modulation) audio circuits. Table 1 lists the most important parameters. From these, it should be clear why in this case ICs with 16-bit resolution should be chosen (although 14-bit converters are sometimes used): they have a signal-to-noise ratio of 107.1 dB and a dynamic range of 96.3 dB.

### Linearity, gain, and offset errors

Curves representing these three errors are given in figure 5. Taken in conjunction, they result in a quantization error that does not look as uniform as that in figure 4. However, this combined error is no longer caused by the system alone, like the quantization error, but is caused mainly by production techniques and temperature-dependent external factors. The **offset error** is the shift on the x axis of the actual conversion characteristic as compared with the ideal one (which would, of course, go through zero). The **gain error** is, strictly speaking, a scaling error: it is the difference in slope between the actual and the ideal transfer characteristic. (This assumes that the offset error has been cancelled out).

The **non-linearity** is interpreted in two ways. In the first, it is seen as an **integral linearity error** (figure 5c), i.e., the maximum deviation from a straight line drawn between the end points of the converter's transfer characteristic. In the other, it is considered a **differential linearity error** (figure 6), i.e., the maximum deviation of each conversion step from its ideal value, which is the FSR (full scale range) divided by  $2^n$ , where  $n$  is the resolution in bits.

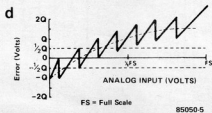

When selecting converter ICs, you must, of course, not treat these values as absolute. For instance, for an A/D converter for PCM audio, the maximum distortion figure is of far greater importance than the maximum linearity error!

### Digital-to-analogue converter

D/A conversion can be effected by a number of methods, of which two are considered. The first is the current output system, schematically shown in figure 7. Here, the bits are converted into constant currents,  $I_0$  and  $I_1$ . When the input bit is logic 1 or logic 0, the two currents are equal, so that the output of the differential amplifier to which the currents are fed is 0 V. If the currents are not the same, the output of the amplifier has a finite value. Let us consider an example based on figure 7, whereby a digital audio signal is converted to an analogue one. The converter IC is, of course, a 16-bit type. The output voltage of the differential amplifier is applied to a sample-and-hold stage which effectively suppresses any glitch. Then follows a low-pass filter which removes any scanning noise, and finally the analogue signal appears at the output. This type of arrangement, which can be found in CD (compact disc) players, for instance, has a maximum distortion factor of only 0.005 per cent over a bandwidth of 20 kHz and a dynamic range of 96 dB. Sixteen-bit D/A converters are available which combine the current output and R-2R techniques. The four most significant bits (MSBs) are then processed by the current method and the four least significant bits (LSBs) by the R-2R technique. According to manufacturers' specifications, this reduces both the differential and the integral linearity errors to values well below those associated with other conversion systems.

The second technique is based on an R-2R resistive ladder network as shown in figure 8. Only one branch of the ladder is connected to  $U_{REF}$  at a time, and the remaining ones are earthed. A current is produced in each branch in succession (the switches are electronic types). This current flows through the ladder and is divided by 2 at each junction. Therefore, the contributory current from each branch flowing through load  $R_A$  is binarily weighted in accordance with the number of junctions through which it has passed. The resulting voltage produced across  $R_A$  is therefore

$$U_A = U_{REF}/2^1 + U_{REF}/2^2 + \dots + U_{REF}/2^n$$

where n is the number of branches.

This voltage is compared, in steps, with the digital input voltage (see also the article *digitizer* elsewhere in this issue).

The resulting voltage produced across  $R_A$  is therefore

$$U_A = U_{REF}/2^1 + U_{REF}/2^2 + \dots + U_{REF}/2^n$$

where n is the number of branches.

This voltage is compared, in steps, with the digital input voltage (see also the article *digitizer* elsewhere in this issue).

The resulting voltage produced across  $R_A$  is therefore

$$U_A = U_{REF}/2^1 + U_{REF}/2^2 + \dots + U_{REF}/2^n$$

where n is the number of branches.

### Final points

In your search for the solution to your conversion problem, you may not be able to find the ideal. You will, therefore, have to come to a compromise, particularly as regards the cost, because prices are high! Sony, for instance, lists a 100 MHz A/D

Table 1.

Resolution (n)	States ( $2^n$ )	Binary Weight ( $2^{-n}$ )	Q for 10 V FS	S/N Ratio (dB)	Dynamic Range (dB)	Max Output for 10 V FS (V)
4	16	0.0625	0.625 V	34.9	24.1	9.3750
6	64	0.0156	0.156 V	46.9	36.1	9.8440
8	256	0.00391	39.1 mV	58.9	48.2	9.9609
10	1024	0.000977	9.76 mV	71.0	60.2	9.9902
12	4096	0.000244	2.44 mV	83.0	72.2	9.9976
14	16384	0.0000610	610 $\mu$ V	95.1	84.3	9.9994
16	65536	0.0000153	153 $\mu$ V	107.1	96.3	9.9998

FS = full scale

converter board at around £3000! Perhaps you had better look at the *digitizer* featured elsewhere in this issue!

### Literature:

*Full Line Catalog 1984 and Application Notes*

Micro Power Systems, Santa Clara, USA

*Data Acquisition Handbook*

Intersil, Cupertino, USA

*A/D and D/A Conversion Manual*

Motorola

*Data Book of Analogue Devices*

Burr-Brown; Harris; National Semiconductor

*A/D and D/A conversion*

*Elektor (UK)*, March 1982, pp. 3-43 to 3-46

Table 1. Parameters for data conversion

Glitch or skew is a spurious pulse of very short duration caused by the switching from one conversion state to the next and may be accepted as a bit.

7

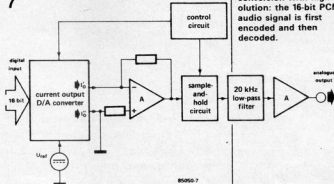

Figure 7. Example of D/A conversion with high resolution: the 16-bit PCM audio signal is first encoded and then decoded.

8

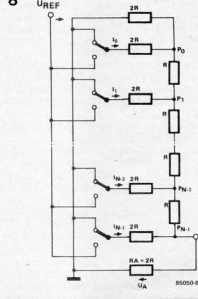

Figure 8. Block diagram illustrating the R-2R technique.

# programmable timer



M. Kuijk

This truly versatile timer offers eight switched outputs that enable each day of the year to be programmed; repeat functions; the facility to access no fewer than 149 multiple, or 199 single, switching programs; an eternal calendar that tells you in a jiff on which day 17 January 2011 will fall; a front panel with built-in keypad switches; and much more...

with a host of facilities

To start with, we want to put your mind at rest about the timer being difficult to operate with all those facilities. It has been designed with ease of operation in mind, so that after half an hour's initiation you will know the timer inside out!

The timer shows, of course, the correct time and date. Leap years have been pre-programmed, so you will never have to do anything about these. There are eight outputs that can be switched manually or automatically; the output status is always displayed on the front panel.

The eternal calendar is programmed up to 1 January 2100. If you want to know on which day your birthday falls next year, just key in the date and the DAY LEDs will show you at once the corresponding day.

The outputs of the timer can be programmed in numerous ways, as a few examples will show. On 16 August, output 3 switches on from 12 noon till 1 p.m. On 7 May, outputs 1, 2, and 8 switch on at midnight, and switch off again on 12 May at 7.30 a.m. These are single switching times, as there is only one switch-on time

and one switch-off time per program. The number of outputs that can be switched by each program is 1...8. The timer can store up to 199 of these single programs. Multiple programs are also possible. For example, outputs 3 and 4 switch on every day at 7.30 a.m. in February, March, and December, and switch off again at 8 a.m. the same day. Outputs 1, 6, and 7 switch on every Saturday and Sunday in June and July between 12 noon and 1 p.m. Output 2 switches on between 7 p.m. and midnight on the first day of every month, but only if that day falls on a Monday. Output 5 switches on from 9 a.m. till 5 p.m. on 2, 12, 23, 29, and 30 September. The timer can store up to 149 of these multiple programs. Where single and multiple programs are mixed, the total number of programs will be 149...199 depending on the mix. The timer will indicate when the memories are full.

## Circuit description

Although the timer contains a fair number



of components, there is not all that much to be said about the circuit. Essentially, the timer consists of a small computer and the electronics for controlling the displays and LEDs.

The CPU (central processing unit), IC1, is a type 6809. The timer program is contained in IC3, a type 2732 EPROM. Data are stored in a CMOS RAM (random access memory), IC2, while data communication is controlled by IC4, a type 6522 VIA (versatile interface adapter). The reset (RES) input of the CPU is connected to an RC network that ensures the resetting of the circuit at each power on. The FIRQ (fast interrupt request) input of the CPU is connected to the secondary winding of the mains transformer, so that a frequency of 50 Hz exists at this pin. This

frequency is used as a time reference for the clock. In case of mains failure, the program automatically arranges for the timer to continue operating from built-in NiCd cells and crystal X1. At the same time, the displays are switched off to minimize current consumption.

Address decoding has been kept simple. Address decoder IC5 uses address lines A11...A13. The RAM, IC2, is enabled by output "0"; the EPROM, IC3, by outputs "6" and "7"; and the VIA, IC4, by output "2". Latch IC6, containing the status of the eight switched outputs, is enabled by "3" via gates N1 and N4. The latch is followed by a number of buffers, N5...N12, whose outputs are intended to be connected to relays for the switching of any equipment controlled by the timer. Each buffer can

programmable timer

Figure 1. The circuit diagram of the programmable timer.

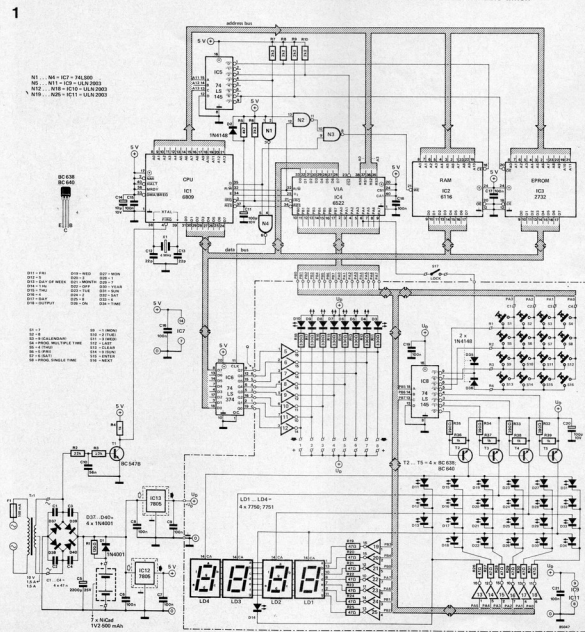

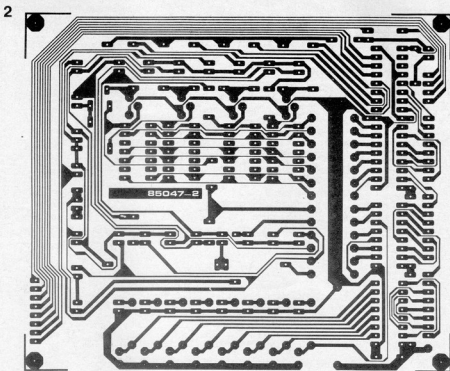

Figure 2. The printed circuit board for the display section.

BCD = binary coded decimal

switch up to 80 mA. Note that the output of an active buffer is logic low, so that any relay must be connected between the positive supply line and the output of a buffer. On the pcb there is, therefore, a +5 V terminal adjacent to each buffer output pin. LEDs D3...D10 indicate the outputs status of the buffers.

The remaining LEDs, D11...D34, and the displays are controlled by port lines PA0...PA7 and PB0...PB7 of the VIA, IC4. Lines PB5...PB7 are additionally connected to a BCD-to-decimal decoder, IC8. Outputs "4"..."7" of this decoder are used for the key matrix, while outputs "0"..."3" drive transistors T2...T5, which in turn arrange the multiplexing of the displays

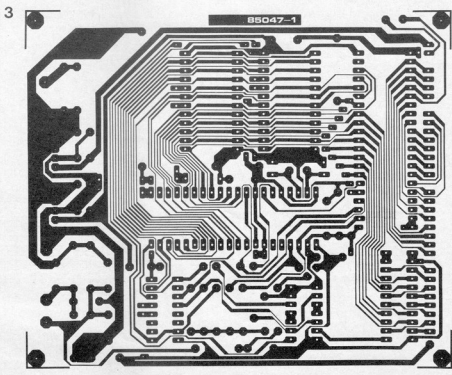
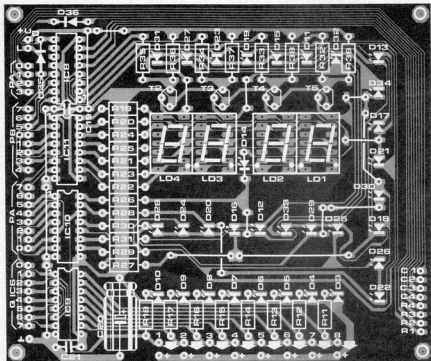
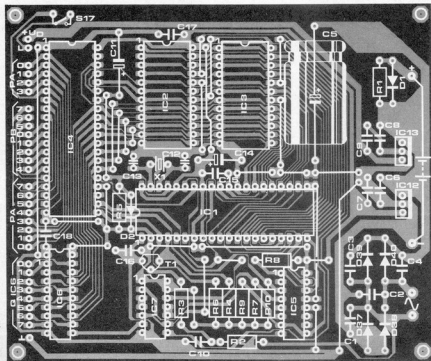

Figure 3. The printed circuit board for the processor section.



and LEDs D11...D34. The segments of the displays are controlled by gates N19...N25; the LEDs by gates N13...N18. The keyboard matrix contains a locking switch, S17, which ensures that the programs cannot be altered by unauthorized persons. It is obvious that, unless it is key operated, this switch must be situated out of sight.

The power supply contains two 5 V regulators: one for the supply line to the LEDs and displays, and the other for the remainder of the circuit. When the mains fails, the power to LD1...LD4 and D3...D34 is switched off. Apart from being necessary for the total current consumption of the clock, the regulators also obviate feedback to the control elec-



programmable timer

#### Parts list

##### Resistors:

- R1 = 120  $\Omega$
- R2, R3 = 22 k
- R4, R36...R39 = 1 k
- R5 = 4k7
- R6...R10 = 2k2
- R11...R18 = 330  $\Omega$
- R19...R31 = 47  $\Omega$
- R32...R35 = 390  $\Omega$

##### Capacitors:

- C1...C4 = 47 n
- C5 = 2200  $\mu$ /25 V
- C6...C9, C15...C19, C21 = 100 n
- C10 = 56 n
- C11, C20 = 100  $\mu$ /10 V
- C12, C13 = 22  $\mu$
- C14 = 10  $\mu$ /10 V

##### Semiconductors:

- D1, D37...D40 = 1N4001
- D2, D36, D36 = 1N4148
- D3...D13, D15...D34 = LED, red, 5 mm
- D14 = LED, red, 3 mm
- T1 = BC 547B
- T2...T5 = BC 638 or 640
- IC1 = 6809
- IC2 = 6116
- IC3 = 2732
- IC4 = 6522
- IC5, IC8 = 74LS145
- IC6 = 74LS374
- IC7 = 74LS00
- IC9, IC10, IC11 = ULN 2003
- IC12, IC13 = 7805

##### Miscellaneous:

- S1...S16 = sixteen-way keypad in front panel
- S17 = single pole, single way switch, preferable key operated
- F1 = fuse, 100 mA, delayed action, with holder
- LD1...LD4 = seven segment display (Regisbrook Ltd - Unit 5, Horseshoe Park, Pangbourne, Berks. Phone: (073 57) 4841)
- X1 = crystal, 4 MHz, with HC18U or HC25U case
- Tr1 = mains transformer, secondary 10 V/1.5 A
- Connector to terminate cable from keypad; e.g., Molex 7583-CNA-08
- Front panel 85047 - 165 x 90 mm
- PCB 85047-1 - 125 x 105 mm
- PCB 85047-2 - 125 x 105 mm
- NiCd cells (7 off) 1.2 V/0.5 Ah

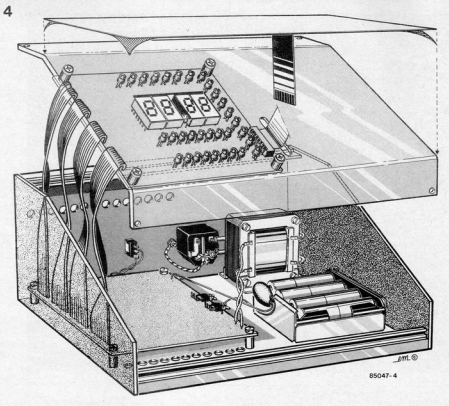

Figure 4. Sketch of a possible construction of the programmable timer.

tronics of pulses caused by the multiplexing of the displays and LEDs. The back-up NiCd battery, providing an emergency supply via D1, is trickle charged via R1 during normal mains operation. The current consumption during mains failure amounts to 250...300 mA, so that the battery will be able to drive the timer for about an hour.

### Construction

The timer is best constructed in a sloping case as shown in figure 4; the dimensions of the two pcbs are 125 × 105 mm. One pcb contains the displays, LEDs, and relevant driver stages (figure 2), while the other houses the remainder of the circuit (figure 3).

First complete the processor pcb; use sockets for the ICs. The wire links should be of not too thin wire. The regulator ICs must be fitted at the track side of the print with their plastic side towards the edge of the board. After they have been soldered, bend them towards the edge of the board in such a way that their metal edge is about 10 mm (3/8 in) off the underside of the board.

Next, complete the display board; again use sockets for the ICs and not too thin wire for the links. The LEDs must be mounted on a level with the displays. The case should be of dimensions suitable for the front panel, which contains all the key switches. The front panel is delivered with a template for the preparation of the sloping panel of the case. The display board is mounted directly

behind the sloping panel in such a way that the displays and LEDs just do not protrude through the holes you have drilled and filed. The processor board is fitted on nylon spacers (to prevent short circuits) to the base panel just under the display board. The mains transformer is fitted towards the rear of the case. Locking switch S17 (unless key operated), the mains input connector, the fuse holder, and possibly the terminals of the switched outputs should be fitted in the rear panel. The holder for the NiCd battery is best fitted alongside the processor board in the bottom. The 31 connections between the two pcbs are best made in flat ribbon cable. The metal flange of both voltage regulators must be screwed to the base panel of the case; use heat conducting paste between the flange and the case. Finally, solder the rest of the wiring in place.

Ventilation holes should be drilled (unless already provided) in both the base and the back panels. Also, fit four rubber feet to ensure good ventilation.

When the case is ready, fit the front panel: first remove the backing paper, push the keyboard cable through the slot, and then stick the panel in the right place. Locate it carefully, because once it is stuck, it cannot be shifted. It is, therefore, advisable to do a dry run. Connect the keyboard cable to the display, and the timer is ready for use.

### Switching of external equipment

There is ample room left in the case for

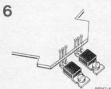

Figure 6. Fit the voltage regulators like this.

Table 1. The hex dump of the program for the timer.

Table with 3 columns: Hex address (left), Hex dump (middle), and ASCII characters (right). The table contains data from address 0000 to 3FBF.

fitting small relays that can switch external equipment, but often it is more convenient to fit the relay in or near the equipment to be controlled. It is also safer in the case of mains-operated equipment. The relay coils should be rated at 5 V and not draw more than 80 mA: that current is the maximum the buffer stages can pass when all eight outputs are active simultaneously. If that situation does not arise with you, the current through the relays may be increased to about 100 mA. The relay contacts should be shunted by a spark suppressor consisting of a 100  $\Omega$ /1 W resistor in series with a 100 n/630 V capacitor. Remember that the relay should be connected between the positive supply line and the relevant buffer output!

The power supply of the timer has a reserve of about 150 mA which is available for the relays. If more is required, an additional 5 V supply must be provided. The relays are then connected between the positive output of that supply and outputs 1...8. The 0 line of the additional supply must be connected to the earth of the timer circuit.

Various methods of switching mains-operated equipment can be found in *solid state relay (Elektor (UK), June 1982)*, *amplified triac drive (Elektor, August/September 1983)*; *triac control board (Elektor, April 1984)*; and *photo electronic relay (Elektor, August/September 1984)*. These electronic relays do not require an additional 5 V supply, because their drive current is only a few milliamperes.

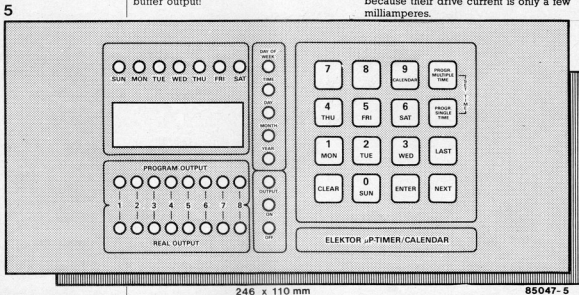

Figure 5. The front panel of the programmable timer.

## Operating instructions

### Displays and LEDs

HH:HH indicates time and date; centre LED lights every second.

SUN...SAT indicate day of the week.

PROGRAM OUTPUT indicates the status which the switched outputs should have according to the program.

REAL OUTPUT indicates the real status of the switched outputs.

DAY OF WEEK...OFF: these eight LEDs indicate what is shown on the display. The first five are self-explanatory. OUTPUT refers to the switched outputs, while the ON and OFF LEDs indicate during programming whether the keyed-in data refer to an "on" or "off" function.

### Keys

0...9 are intended for keying in of data, such as time and date. Keys 1...8 enable selection of

the wanted outputs during programming, and manual control of the eight outputs during normal use. When a key is pressed, the logic level of the output is reversed. Keys 0...6 are also used during programming of multiple times for keying in the day of the week. In normal operation, keys 0 and 9 have a special function: when time is displayed and either of these keys is pressed, the weekday corresponding to a given date can be calculated (eternal calendar); more about this later.

CLEAR deletes the reading of the display in case an error was made during the keying in of data. When the output LED lights during programming, and the CLEAR key is pressed, the current program is deleted completely.

ENTER after data (e.g., time or date) have been keyed in, pressing the ENTER key causes the

timer to store the data in its memory.

**NEXT** enables reading a program without changing it. When time is displayed, pressing NEXT once causes the date to be displayed for four seconds; pressing it twice causes minutes and seconds to be displayed. Time display will return on pressing NEXT one more time.

**PRO M** enables programming and checking multiple times. Programs may be read by pressing PRO M several times, or keeping it down. In the latter case, all eight program output LEDs light every half second, indicating that then programs have been read. Pressing this key once more causes a return to the time display.

**PRO S** enables programming and checking single times, i.e., programs that switch on one or more given outputs at a certain time and date, and switch off again at a different time and date. The key function in all other respects as the PRO M key.

**LAST** enables going back one or more programs when the timer is in the programming mode.

## Time

### Entry of time

- After the mains has been switched on, the timer is on 0.00 and YEAR
- Key in the year, followed by pressing ENTER.
- The display will show 1 0| and DAY and MONTH light.
- Key in the day and month and press ENTER.
- The display will show 0 00 and TIME lights.
- Key in the correct time (hours and minutes) and press ENTER: the timer then commences and the weekday is indicated.

### Correcting of time

- Keeping PRO M (or PRO S) pressed, also press PRO S (or PRO M). Pressing NEXT will then cause all time data to be displayed.
- If anything needs correcting, press CLEAR, key in the new data, and press ENTER.
- During correcting, time continues to run. Only after a new time has been keyed in, followed by ENTER, will the clock run from the new time.

### Eternal calendar

- Press 0 or 9, when the current year will be displayed, and YEAR will light.
- Key in the required year, followed by

ENTER; then day and month, again followed by ENTER. The SUN...SAT LEDs will indicate which day corresponds to that date.

- Press NEXT, when normal time will be displayed again.

### Miscellaneous

- Press NEXT once, when the date will be displayed for four seconds.
- Press NEXT twice, when the minutes and seconds will be displayed; these will remain displayed until NEXT is pressed once more.
- Keys 1...8 enable the manual switching of the outputs; the output status will be indicated by the REAL OUTPUT LEDs.

## Programming

### Single times

- Press PRO S, when OUTPUT will light.
- Select the wanted output with keys 1...8, when the corresponding PROGRAM OUTPUT LEDs will light; when the key is pressed again, the LED will go out.
- Press ENTER, when ON, DAY, and MONTH will light to indicate that the switching on date should be keyed in.
- Key in the date and month, followed by ENTER, when ON and TIME will light to indicate that the switching on time should be keyed in. Key in that time, followed by ENTER, when OFF, DAY, and MONTH will light to indicate that the switching off date should be keyed in.
- Key in the date and month, followed by ENTER, when ON and TIME will light to indicate that the switching off time should be keyed in.
- Key in the switching off time and press ENTER, when the relevant PROGRAM OUTPUT LEDs will light again.
- If required, check all keyed-in data with the NEXT key. Where necessary, corrections may be entered (new data, followed by ENTER).
- If more switching programs have to be entered, press the PRO S key and proceed as above. Otherwise, press PRO S again, when normal operation will resume.

### Multiple times

- Press PRO M, when OUTPUT will light.
- Select the wanted output with keys 1...8, and press ENTER, when MONTH will light.
- Key in the switching on month, followed by ENTER. More months may now be keyed in, if required, each time followed by ENTER.
- After the last month has been keyed in, repeat all keyed-in months with the NEXT key. After the last month

PRO M = progr.  
multiple time

PRO S = progr. single  
time

has been displayed, the timer goes to DAY.

- Key in one or more dates as required, each date to be followed by ENTER. Check with the NEXT key; after the last date, DAY OF WEEK will light.
- Key in one or more days of week and then ENTER (in this case NOT after each day). This allows, for instance, that only when the 15th and 23rd of February and March fall on a Sunday or Saturday, output 1 switches on from 9 a.m. till 11.30 a.m. If this facility is not required, just press ENTER. This also applies to months and dates: if no month is keyed in, the switching on and off times will apply to the stated dates in every month. It is also possible to program only weekdays (i.e., no months or dates); the cycle will then repeat itself every week.
- After DAY OF WEEK, ON and TIME will light to indicate that the switching on time should be keyed in.
- When that is done, OFF and TIME will light to indicate that the switching off time should be keyed in.
- When the switching off time has been keyed in, followed by ENTER, when the relevant PROGRAM OUTPUT LEDs will light again.

- If more switching programs have to be entered, press the PRO M key and proceed as above. Otherwise, press PRO M again, when normal operation will resume.

### Checking and deleting programs

If, at a later date, it is required to add a program, press the PRO M or PRO S key several times until none of the PROGRAM OUTPUT LEDs lights to indicate that the position reached is free. If these keys are kept down, the search is much faster.

The PRO M and PRO S keys enable a forward run through the programs; the LAST key permits a backward search. In the programming mode, checking of a program is always possible with the NEXT key; corrections may be made with the CLEAR and ENTER keys. A complete program may be deleted by locating it with the PRO M or PRO S key and pressing CLEAR. All following programs will then automatically shift up one place.

**Remember** that the actual status of the outputs is indicated by the REAL OUTPUT LEDs!

**Remember** that when the locking switch is open, the programming functions (and setting the time) are disabled!

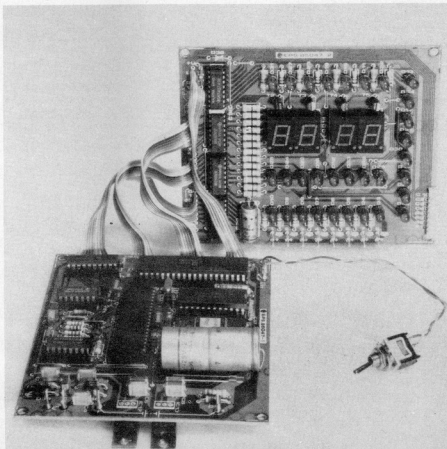



A computer without an I/O (input/output) facility may be compared with a telephone without a receiver: it probably works all right, but you cannot tell. In the same way, a computer can only be used properly when it can be connected to external equipment or networks. It is for that reason that we have designed an I/O interface for the Commodore 64, but which may also be used with most other personal micros. It permits the computer to be connected to digital/analog converters, digitizers, parallel and serial interfaces, sound generators, and many more.

# universal I/O bus

For some obscure reason, connecting external equipment to a computer often causes problems. And yet, the usefulness of a micro depends primarily on the facility for using peripheral equipment. In many cases, the I/O facility is severely restricted and this acts as a brake to the inventiveness of many computer users. This void may be filled with the proposed universal I/O bus. The word 'universal' is used deliberately, because the bus can be connected to virtually any computer system. It offers four independent I/O ports to which a number of external units or networks may be connected.

## Design considerations

A computer system is nothing but an array of interfacing units with at the centre the microprocessor, the memory, bistables, and ports. To enable this core to work with the peripheral equipment: compilers, assemblers, operating systems, printers, monitors, and so on, it needs a means of communicating with these units. This data transfer may take place via specific ICs, such as PIAs (peripheral interface adapter), VIAs (versatile interface adapter), or ACIAs (asynchronous communications interface adapter). Such circuits are normally used for the keyboard connection, the printer connection, or the serial interface.

There is a more direct way: via the databus of the system. This form of input/output can be achieved by I/O mapping or memory mapping, depending on how the memory is arranged (see figure 1).

In I/O mapping, the memory locations allocated to the input/output ports are separated from the memory proper by control lines, for instance, IOR (I/O read), or IOW (I/O write).

In memory mapping, the I/O allocations are contained within the memory itself, which is, therefore, divided into memory and I/O locations. Each I/O location is, in essence, an I/O port. The data bus is split over the various port connections by address decoders.

The proposed design uses memory map-

ping, as this enables it being used with a greater variety of computers. None the less, it can also use I/O mapping, as will be seen later in the article.

## Block schematic

The proposed I/O bus is shown schematically in figure 2. The address bus, data bus, and control bus emanate from the computer. The highest address lines, A4...A15, are taken to the I/O range decoder, which determines the range of the I/O ports. A memory range of sixteen sequential addresses may be selected for the I/O with memory range switches. In this range, the data lines are connected to the ports (slots 1...4) via the buffer. The range is divided into four groups of addresses, each of which has four locations: the real I/O ports. Address lines A1 and A0 are connected to the slots to enable the individual selection of the four addresses.

The location of the I/O range in the memory is arbitrary. If the I/O range switches are set to a value of 400 hexadecimal (the first three nibbles of the I/O addresses), slot 1 will extend from 4000 to 4003 incl.; slot 2 from 4004 to 4007

for the Commodore 64 and many other micros

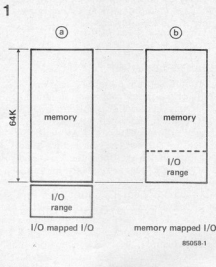

Figure 1. This illustrates the difference between I/O mapping and memory mapping.

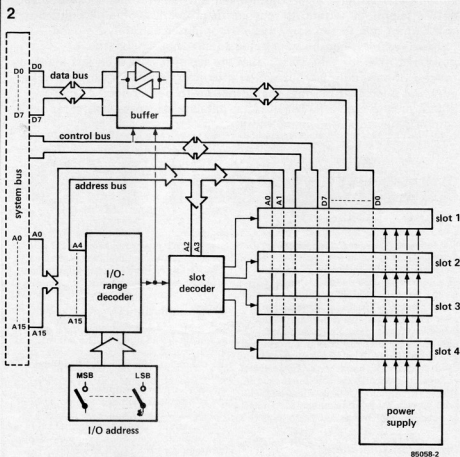

Figure 2. Schematic representation of the universal I/O bus.

incl.; slot 3 from 4008 to 400B incl.; and slot 4 from 400C to 400F incl. It is clear that, to prevent double addressing, these locations must not be occupied by the memory proper.

There is also a control bus with a read/write output for input and output respectively, a common reset and interrupt line, and a  $\Phi 2$  signal for a possible synchronization facility.

An external supply (+5 V;  $\pm 12$  V) may be connected to augment the existing power supply in the computer.

### Circuit description

The circuit diagram of figure 3 is reminiscent of the block schematic in figure 2. The I/O range decoder is formed by IC3 and IC4. These cascaded 8-bit devices compare address lines A4...A15 with the code set by DIL switches S1 and S2. When these lines match the code, the  $P=\bar{Q}$  output of IC4 becomes active, and the consequent output signal is applied to the enable input of both IC1 and IC5 via wire link b. The data direction of buffer IC1 is reversed by the R/W (read/write) signal. Dual 2-to-4 line decoder IC5 decodes the four slot select signals, SS1...SS4, from the sixteen I/O locations. This means that each slot has four sequential addresses. The slot select signals can finally be used

as enable signals (active = logic low) for ICs, buffers, and the like.

Each slot also contains the eight data lines, the R/W, the NRST (negative reset), the IRQ (interrupt request),  $\Phi 2$ , and the power lines (+5 V;  $\pm 12$  V; earth). Address lines A1 and A0 represent four address locations in a slot. These are often used for register select inputs of VIAs and similar devices. The synchronization clock,  $\Phi 2$ , is also more often used with peripheral ICs. There is a facility on the bus board to synchronize the data bus signals with  $\Phi 2$  (wire link f) to obviate so-called bus conflicts.

Finally, the system bus has connections BUS SEL (bus select) and BUS ACK (bus acknowledge). The bus select input may be used for external actuation of the I/O bus (so-called half-memory mapped), while the BUS ACK output indicates when the bus is actuated. This signal may be fed back to certain computers to switch off the memory.

Power for the circuit is normally drawn from the +5 V supply in the computer. If that supply is thereby stretched, or if several levels of voltage are required, the auxiliary supply given in figure 4 may be used. This provides +5 V,  $\pm 12$  V via three 1 A regulators. When the auxiliary supply is used, the +5 V from the computer must **not** be used, but the earth or power return lines must, of course, be interconnected.

## Construction

The bus is most conveniently built on the pcb illustrated in figure 5. The peripheral pcs should be inserted into the slot connectors at right angles to the board of figure 5. We have not indicated the connections to the computer, because there is such a multitude of differences between the various makes that this becomes totally impracticable.

When the auxiliary power supply is used, the +5 V connection must not be used. The DIL switches are mounted so that,

viewed from the system bus, the MSB (most significant bit) is at the left, and the LSB (least significant bit) is at the right. This facilitates the locating of the I/O range.

## Operation

After the bus has been built and thoroughly checked, it is connected to the computer. As there are so many differences between various makes of computer, it is not possible to give connection

universal I/O bus

Figure 3. Circuit diagram of the universal I/O bus.

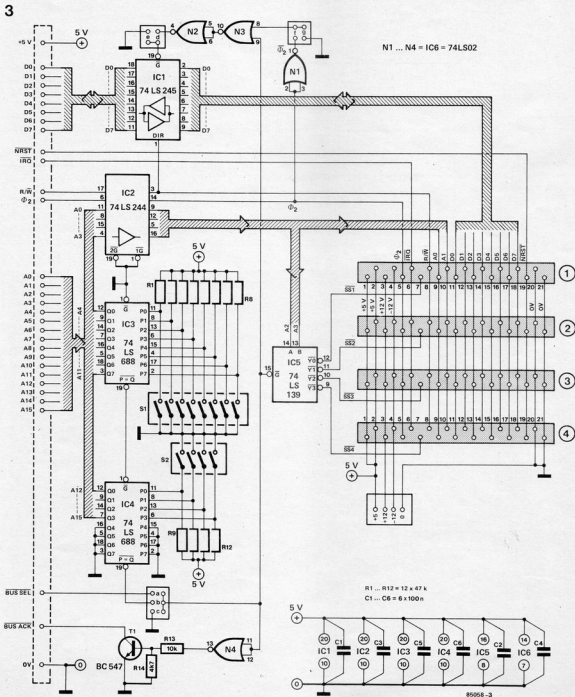

4

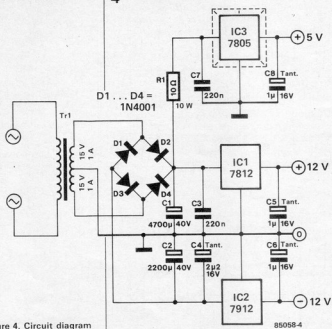
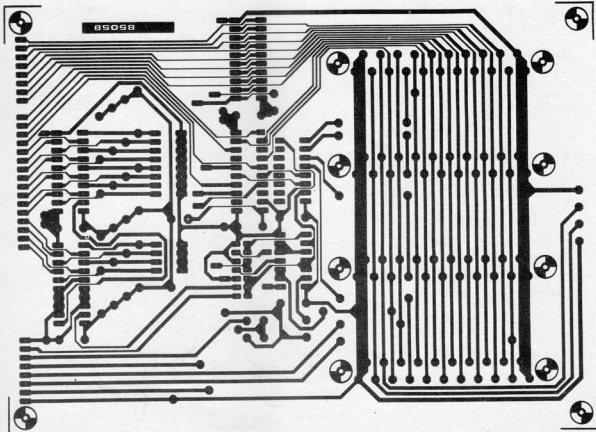

Figure 4. Circuit diagram of the optional auxiliary power supply.

instructions for all micros in detail. In the Commodore 64, the expansion connector is used; the pin designations of this are given in figure 6. Pins D0...D7,

5

Figure 5. The printed circuit board of the I/O bus.



A0...A3, IRQ, Φ2, GND, and possibly +5, are connected to the corresponding terminals on the bus board. RESET is connected to NRST, and I/O select output I/OI is connected to the BUS SEL input. Output I/OI represents I/O address range DE00...DEFF, so that the slots are occupied as follows:

- slot 1 — DE00...DE03;
- slot 2 — DE04...DE07;
- slot 3 — DE08...DE0B;
- slot 4 — DE0C...DE0F.

Finally, fit wire links a, d, and f on the bus board, and then you can peek and poke to your heart's content.

As far as other makes of computer are concerned, first set the functions of the bus with wire links a...g. If the computer contains a full data, address, and control bus, the bus decoding is effected by IC3 and IC4. This means that wire links b and d should be fitted. After that, reading and writing can take place in the selected addresses. Switches S1 and S2 set the beginning of the I/O range. If that is, for instance, 4000<sub>hex</sub>, the switches are set, from left to right: 010 000 000 000 (0 = switch closed; 1 = switch open).

If you select a constant enable of the bus, for instance, with control by a PIA, fit wire links c and e. This precludes address decoding in IC3 and IC4.

If, instead of a complete system bus, only user ports are available, the bus can be

connected via a round about way. Signals BUS SEL, A0, A1, A2, and A3 are then taken to a separate user port and can then be controlled by a (somewhat more complex) poke. In this case, fit wire links a and d. This method may also be employed in case of control by a PIA. Here again, the decoder function of IC3 and IC4 is disabled.

The BUS SEL input can also be used where a decoded address is already available on the bus, for instance, with existing applications. Addresses A0...A3 are as normal put onto the address bus, and BUS SEL onto the select output of that decoded address range (which is active at low logic levels). In this case, fit wire links a and d.

The synchronization clock,  $\Phi 2$ , is, apart from at the ports, also present in the bus circuit itself, and can, therefore, be used to synchronize the data bus. This is not always necessary (for instance, where the system bus of the computer is already synchronized), but it does not do any harm. If the facility is used, fit wire link g. The indications to the system bus connections only apply to 6500 and 6800 systems. Signals R/W and  $\Phi 2$  do not exist in Z80 systems. Instead of  $\Phi 2$ , the  $\overline{\text{IOREQ}}$  signal can then be used, while in place of R/W the WR signal may be employed.

As you can see, interconnecting the bus and your specific computer requires some

thought, but, with the guide lines given, it should be fairly straightforward. As far as the frequency of the system clock is concerned, the bus circuit presents no problems. If, for instance, the micro operates at 2 MHz, the peripheral units should obviously be able to cope with that.

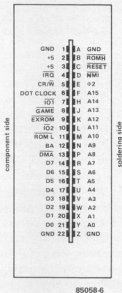

Figure 6. Pin out of the expansion port of the Commodore 64.

#### Parts list

Resistors:  
R1...R12 = 47 k  
R13 = 10 k  
R14 = 4k7

Capacitors:  
C1...C6 = 100 n

#### Semiconductors:

T1 = BC 547  
IC1 = 74LS245  
IC2 = 74LS244  
IC3, IC4 = 74LS688  
IC5 = 74LS139  
IC6 = 74LS02

#### Miscellaneous:

S1 = DIL switch, 8-pole, single throw  
S2 = DIL switch, 4-pole, single throw  
4 connectors, 21-way, to DIN 41617  
single row block with four screw terminals for 0.1 inch matrix  
dual row terminal strip for 0.1 inch matrix, each row of 7 pins  
three shorting links to fit terminal strip  
pcb 85058

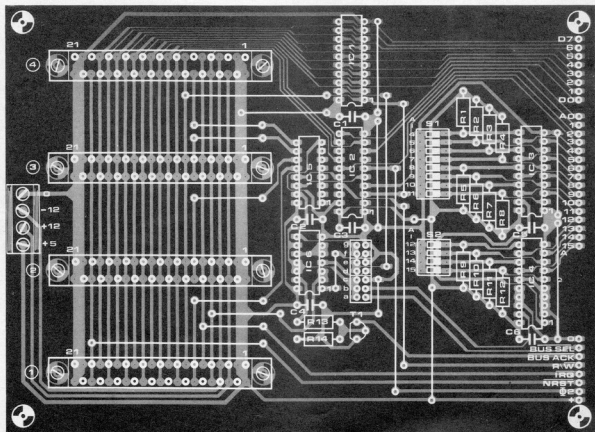

# an IBM compatible micro

A great many people would love to own a really first class personal computer, but are defeated by the cost of such a machine. It is for those people that we have designed a PC that is compatible with what is currently probably the best PC around. We had planned to publish the project this month, but, unfortunately, owing to lack a space this was not to be. It will, however, definitely appear in these pages next month. Our apologies to all those keen readers who would have liked to make an immediate start!

In principle, it is possible to build any computer yourself, presupposing, of course, that you can obtain all the necessary parts. This is true even for an IBM PC2 compatible, which will give you an entree to the 16-bit world and a mass of efficient software. Note well that this software is immediately usable: it does not have to be modified in any sense. There are not all that many IBM compatible machines, and most of those are Japanese. It is an open question why so few home-made IBM compatible machines exist. Is it because most people think it is too difficult? We have tried to find the answer to that question, and can now say that it is not: the prototype is working very satisfactorily in our laboratories and continues to do so.

There is not much to say about the IBM PC2 that is not already well known. This machine has set yardsticks by which all other home computers are measured. Together with its compatible brothers and sisters, it has gained almost seventy-five per cent of the world's home computer markets. Part of its appeal, of course, the tremendous amount of software that does not consist for 80...90 per cent of games. The software ranges from a simple editor (at around £30...£40) to a complete CAD/CAM system at anything from £10 000 upwards, and contains a farm administration program as well as a blend optimization program for the timber, steel, and glass industry.

We have found that building the compatible prototype does not present an experienced electronics hobbyist with insurmountable problems. That does not mean to say that it is easy! We also had no problems in obtaining the required parts. There still remains the question why so few compatible machines exist. As we have seen, it is not the degree of diffi-

culty, nor is it that there is no software available. It cannot be the technology used by IBM: this is pretty well current. We have a feeling that the cause lies to some extent in the typical buyer/user of the IBM PC2 as contrasted with the Apple user. The former are largely small and medium businesses as well as professional people: doctors; lawyers; managers; company directors, who in the main would not dream of building their own computer, whereas the latter includes many electronics hobbyists. Another factor is that, in the main, the technical press has hardly touched upon the subject; at least not as far as we have been able to find in any of the world's technical periodicals. The only 16-bit DIY computers published are not, in the true sense of the word, IBM compatible. Most of these are 68000 machines, the software of which is either wanting or very expensive.

Where the software is offered as compatible, it has often been adapted so badly that the home constructor is still faced with figuring out his own modifications and improvements. At the prices considered here, some £2000...£3000, that is not going to attract a great many people. No, it is far better to build your own compatible and leave those problems to others.

For our prototype we have used the Megaboard (part) construction kit, which is produced by DTC of Dallas, Texas, USA, and which is available from a number of specialist retailers. This kit contains the mother board (complete with component layout foil and solder resist), the Boot EPROM with MEGA BIOS, the memory mapping PROM, and extensive documentation (c. 90 pages) giving full instructions for the construction and operation, and containing all necessary circuit diagrams, timing diagrams, and so on. We advise all those interested to work with this or a similar kit, because then you will not have any problems with the PROM and EPROM; you can, of course, buy those by themselves, but you then have to program them, and that's the crux of the matter. The assembly instructions supplied with the Megaboard kit are a great help with the completion of the mother board. To explain: the IBM PC2 is a modular constructed computer, which means that the mother board contains apart from the processor, RAM banks, and so on, also six (in the IBM PC2), but eight in the case of the Megaboard, positions for extension cards. Two of these at least are needed for the video card and the floppy controller card. And then there are: power supply; drives; keyboard;... All these will, of course, be looked at in detail in the construction article which will be published in our July issue.

CAD = computer-aided design  
CAM = computer-aided manufacture

J. Wallaert

# panorama mixer

a four-channel mixer and balance control in one

Figure 1. This circuit enables a number of signals to be mixed, with each being given a specific position in the stereo image. Each of the signals may come from a different source but must be 'mono'. In effect this mixer is an alternative for the more complex versions in which a phase-shift is used to set the position of a signal.

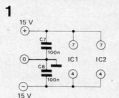

One of the most popular fields of electronics, certainly for hobbyists, has always been audio. This is one of the few areas in which you can actually hear the results of long hours spent designing or building a circuit, which could be anything from a single-chip radio receiver up to a polyphonic synthesizer with all the trimmings. A small part of this field, namely home recording, is becoming ever more popular in its own right. For all enthusiasts of this 'hobby' we have now designed a simple mixer with an unusual feature — a facility for placing a sound anywhere you like in the stereo 'spectrum'.

In home recording the quality of the sound is all-important so it is quite understandable that most enthusiasts are prepared to spend a lot of time and money to get this right. Unfortunately there is then very little left over for special effects that can give a recording a special character of its own. The circuit shown in figure 1 has a dual function. It mixes the signals that are presented to its inputs (four inputs are used in the example shown but this could be more or less) and at the same time it enables each of the input signals to be placed at a particular 'place' in the total sound. What this means, actually, is that there is an individual balance control for each input.

## Four inputs, two outputs

Each of the four input channels to the circuit can be considered separately as each is virtually independent of all the others. The number of channels used can be increased or decreased depending on individual requirements. This is simply a matter of duplicating or deleting the relevant section.

Consider input 1 as the model for all the channels. The d.c. component of the signal presented to this input is removed by

electrolytic capacitor C1. The signal then passes to logarithmic potentiometer P5 where the volume is set. Both IC1 and IC2 are connected as inverting amplifiers whose closed-loop gain for a given input is determined by the ratio of the feedback resistor (R5 or R6) to the resistance between the wiper of P5 and the inverting input (virtual earth) of the op-amp (if we ignore the source impedance of P1 and the audio source). Moving the wiper of P1 from the 'L' extreme to 'R' varies the gain of IC1 from two to one, while at the same time the gain of IC2 goes from one to two. In effect this means that IC1 has a high gain while IC2 has a low gain and vice versa, so the input signal is split between the left and right output channels in a ratio that depends on the position of the wiper of P1. The transfer ratio (output/input) of each channel ranges from zero to two. When the wiper of P1 is in mid-position the gain of each op-amp is the same so the input signal is split evenly between the left and right channels. The wiper of P1 therefore determines exactly where the signal is located relative to the left and right channels. Each of the other channels operates in precisely the same way. The input impedance depends on the position of the wipers of presets P5...P8; output impedance depends on the op-amps (about 60  $\Omega$  with the CA 3140s). The maximum input level is about 7.5 V<sub>pp</sub>.

Building this circuit is quite straightforward and as it is so small it could probably be incorporated within some other equipment. Current consumption depends on the number of channels used but as shown it is about 5 mA. The op-amps indicated give a reasonable performance but this can be improved by selecting low-noise types instead. The circuit can be made more 'user-friendly' by using slider pots for P1...P4 and P5...P8. It is then possible to see at a glance exactly what the volume and 'position' of each channel is with respect to all the others.  $\blacksquare$

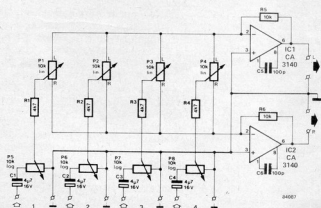

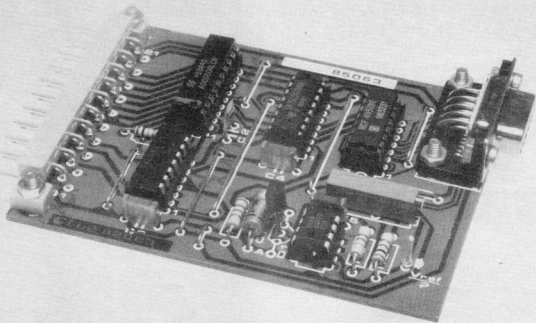

Communication with the outside world is vital for a computer, but most information from that outside world arrives in analogue, that is, continuously varying, form rather than as a series of binary digits, bits, which are the computer's staple diet. The continuously varying signals can be converted into bits by the digitizer presented here. The pcb on which the digitizer is housed fits nicely onto the *versatile input output bus* featured elsewhere in this issue. It comprises a single analogue/digital converter IC, the input of which is connected via software to one of the eight analogue input terminals on the pcb. Operation is simple and effected by BASIC with a single peek and poke command.

# digitizer

the outside link

The layout of the digitizer is fairly simple; yet, its performance is excellent. The printed circuit board (pcb) has eight input terminals, to each of which an analogue signal may be applied. A poke command in BASIC enables the selection of one of the eight input pins which is then connected to the input of the converter IC. The same command serves to start the analogue-to-digital conversion process. Afterwards, the converted bits may be extracted with a peek command for processing in the computer.

## The converter IC

National Semiconductor's ADC0804 is an eight-bit analogue/digital converter that operates by the successive approximation method. It has been designed specially

for use with microprocessors, so that it contains eight data outputs that can be switched to a high-impedance state. The eight outputs tell us at once that the resolution of the converter is  $2^8 = 256$  steps. In the successive approximation method, the input voltage is compared, in discrete steps, with a reference voltage that in binary divided steps approaches the input voltage more and more accurately. The IC therefore uses a ladder network of R-2R resistors and a reference voltage,  $V_{ref}$ . First, half the reference voltage is compared with the input voltage,  $V_{in}$ . If  $V_{in} < \frac{1}{2}V_{ref}$  the highest-numbered output goes logic low, and the reference voltage is reduced to  $\frac{1}{4}V_{ref}$ , which is again compared with  $V_{in}$ . If  $V_{in} > \frac{1}{2}V_{ref}$ , the highest-numbered output goes logic high, and the reference voltage is increased to  $\frac{3}{4}V_{ref}$ . Depending on the result, the reference voltage is reduced or increased by  $\frac{1}{8}V_{ref}$  at the next step; by  $\frac{1}{16}V_{ref}$  the following step; and so on, until all eight outputs have a logic value (1 or 0). The block schematic of the ADC0804 is shown in figure 1. The voltage provided by



the ladder network is set with on-chip analogue switches. The most significant bit (MSB) is tested first, and after eight comparisons (sixty-four clock pulses), the eight outputs of the ladder have a binary code that represents the value of the input signal (1111 1111 = full scale). That code is transferred to the output latches, and at the same time an interrupt signal is given via the INTR bistable.

There are two inputs via which the converter may be enabled: WR and CS, but first, the IC has to be selected by a logic low at CS. When the WR input goes from logic high to low, the on-chip SAR backing stores are reset. As long as CS and WR remain logic low, the converter remains in the reset state. The conversion process does not commence until 1...8 clock periods after at least one of these inputs has gone logic high.

The reset state (both CS and WR logic low) implies the following: the starting bistable, F/F, is set which causes the resetting of the interrupt bistable; the Q output of D-type bistable F/F1 goes high: this logic level is applied to the input of the 8-bit shift register after one clock pulse, and also to the input of AND gate G1. This AND gate combines the "1" with the clock signal into a reset signal for the starting bistable. When after that a "1" is applied to one of the inputs CS and WR, the starting bistable is reset, whereupon the shift register accepts the "1" from F/F1 and the conversion process commences.

After the "1" has been clocked through the shift register, it appears at the Q output of the register to indicate that the conversion can be terminated. This high signal also ensures via AND gate G2 that the digital levels are entered into the output latches. At the next clock pulse, the "1" is written into D-type bistable F/F2, which causes the setting of interrupt bistable INTR F/F, whereupon the INTR output goes logic low via an inverter. For reading the data, the combination CS/RD ensures that the interrupt bistable is reset, and that the data appear at the outputs of the output latches. These outputs are normally high impedance.

### Circuit description

The heart of the digitizer is, of course, the analogue/digital converter, IC1 — see figure 2. Resistor R4 and capacitor C2 are the frequency determining components for the on-chip clock. The WR input, pin 3, is connected direct to the R/W terminal on the I/O bus. The CS input, pin 1, is fed with a combination of  $\Phi 2$  and SS (slot select) via gates N2 and N3. The RD signal for pin 2 is derived from the R/W signal via inverter N1.

The input of IC1, pin 6, is fed from the output, pin 3) of eight-channel multiplexer IC3. The inputs of this IC, pins 1...8, accept analogue signals over a maximum range of 0...5 V. Which of the signals is connected to IC1 is determined by four-bit latch IC2. This latch is controlled via

digitizer

A bistable (multivibrator) is also known as a half-shift register or by its American name flip-flop.

1

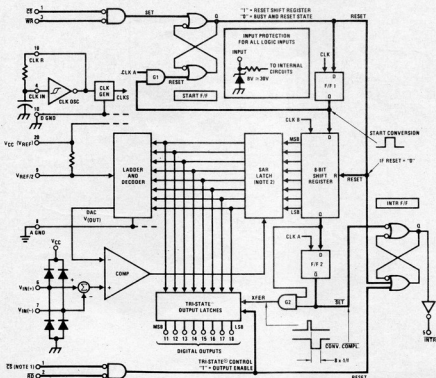

Figure 1. Internal connection diagram of the analogue-to-digital converter IC.

Note 1: CS shown twice for clarity.

Note 2: SAR = Successive Approximation Register.

85063-1

data lines D0 . . D2 and it receives the clock pulses from the  $\Phi 2$  terminal via inverter N4.

The reference voltage is supplied by zener D1 and JFET opamp IC5. The LM 336 reference zener may be replaced by a normal 1.8 . . 2.2 V zener where optimum performance is not so important.

### Construction

If the digitizer is built on the printed circuit board shown in figure 3, no difficulties are likely to arise.

### Using the digitizer

It is important to read the article *universal I/O bus* elsewhere in this issue before taking the digitizer into use. The digitizer is inserted into one of the slots on the I/O bus. Depending on the chosen slot and the setting of the address decoding switches, the digitizer is then located in a given range of four addresses.

First, with the aid of a digital voltmeter, set the voltage at the  $V_{ref}/2$  terminal to exactly 2.5 V with preset P1. The input voltage range then covers 0 . . 5 V. Where a different range is required, the reference voltage must be altered accordingly. The

zener voltage must always be slightly smaller than half the wanted range. If it then proves impossible to adjust P1 for  $V_{ref}/2$ , increase the value of R2.

With a POKE command, write a number between 0 and 7 into one of the four addresses of the relevant slot; this selects one of the eight inputs 0 . . 7 and starts the conversion process. Subsequently, with a PEEK command, the bits can be extracted from one of the four addresses. An additional waiting loop during the conversion is not necessary, because BASIC is so slow that the conversion period of 100  $\mu$ s is over long before the PEEK and POKE commands have been executed. With some analogue signal sources, it may be necessary to extend the procedure somewhat. If, for instance, the source connected to the multiplexer inputs is high impedance, it takes a while (relatively speaking, of course) before the signal is present on pin 6 of the converter. This is caused by the time constant of the source's output impedance and the input capacitance of IC1. This little difficulty is resolved by two identical POKEs in quick succession to the digitizer before a PEEK.

Figure 2. Circuit diagram of the digitizer.

2

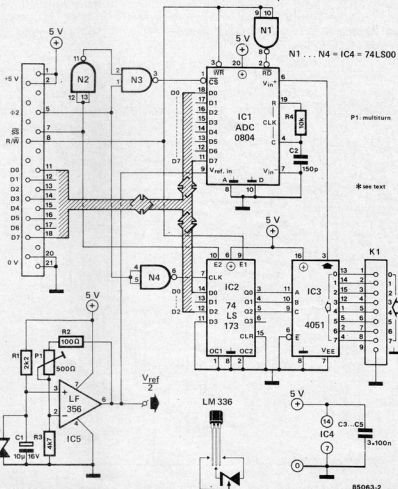

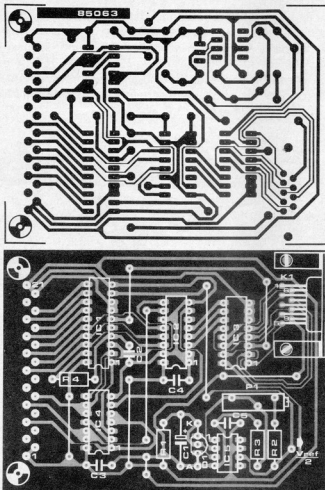

digitizer

**Parts list****Resistors:**

R1 = 2k2  
 R2 = 100  $\Omega$   
 R3 = 4k7  
 R4 = 10 k  
 P1 = 500  $\Omega$  multiterm preset

**Capacitors:**

C1 = 10  $\mu$ /16 V  
 C2 = 150 p  
 C3...C5 = 100 n

**Semiconductors:**

D1 = LM 336, 2.5 V (see text)  
 IC1 = ADC0804  
 IC2 = 74LS173  
 IC3 = 4051  
 IC4 = 74LS00  
 IC5 = LF 356

**Miscellaneous:**

21-way pcb connector, reversed configuration, to DIN 41617  
 9-way pcb connector, reversed configuration  
 PCB 85063

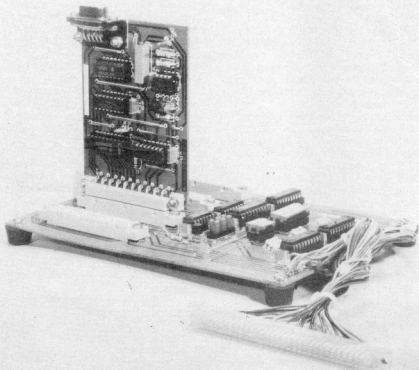

**Figure 3.** Printed circuit board for the digitizer. As shown in photograph 2 this fits nicely into one of the slots of the universal I/O bus.

It is well known that programmable ROMs (read-only memories) can be used not only as a logic building brick, but also as a Boolean operator or complex encoder. For some years now, there has been a better, more flexible, and, last but not least, cheaper alternative to the usual bipolar PROM (programmable ROM): PAL (programmable array logic), not to be confused with the widely used colour television system of the same name (or rather, acronym), or with PLA (programmable logic array).

# programmable array logic

flexibility and high speed at (relatively) low cost

A PAL device is basically a matrix with the same logic arrays as PROMs and PLAs, but, whereas PROMs use fixed AND arrays and programmable OR arrays, and PLAs use programmable AND arrays and programmable OR arrays, the PAL uses programmable AND arrays and fixed OR arrays. In all three types of device, the AND array outputs feed the OR arrays. The PLA provides the greatest flexibility for executing logic functions, since they afford complete control over all inputs and outputs. Unfortunately, they are very expensive, very difficult to understand, and, moreover, they require special programmers. PROMs, on the other hand, are easy to program, relatively inexpensive, and readily available in a variety of sizes. The PAL combines the low cost and easy programmability of the PROM with much of the flexibility of the PLA.

In spite of the ever increasing density of LSI ICs and VLSI ICs, designers still need 'normal' ICs to form the link between CPU, RAM, EPROM, PIA, PIO, and other sections of a computer. When the circuits are very complicated, it becomes quite clear that these 'normal' ICs are not very flexible. Because the only solution is to use great quantities of these ICs, designers have for years been trying to use, often successfully, bipolar PROMs as pseudo logic networks. A PROM programmer enables an empty matrix to be coded with a complicated logic pattern in seconds, resulting in input and output combinations that can be converted into Boolean algebra. An example of this is the *analytical video display* (Elektor June 1984), in which a PROM codes the colour information (RGB). Bipolar PROMs are also eminently suitable for use as address decoders.

The usefulness of PROMs is, however, hampered by the, binary speaking, very limited number of possible input and output combinations. For example, if a circuit with ten inputs and eight outputs is to provide thirteen output functions, it would be very wasteful to use a  $1\text{K} \times 8$  PROM,

because of the possible 1024 input and 256 output combinations only 13 would be used. It is clear that one of the good points of a PROM is that for a given number of inputs it provides all possible output combinations, but a drawback of it is that the number of input variables is rather limited.

## Fusible link technology

Many of you may remember the programmable diode matrices of the sixties: each crossing of a matrix was as it were a fuse which had to be blown to eliminate an OR function on the relevant line. Later came PROMs which had the facility to connect input variables into an AND matrix (see figure 2a). Each input variable is connected to all other input variables. In computer language, the input variables (left-hand column) are the addresses, and the output variables (right-hand column) are the data. The choice between the various AND functions is effected by a programmable OR matrix. The PROM of figure 2a is shown programmed in figure 2b. Some of the fusible links have been blown, so that the logic level of the relevant outputs is 0. There is a total of 2<sup>4</sup> possible combinations.

The internal structure of a PAL device with four inputs and four outputs is shown in figure 3. The only visible difference with figure 2b is that here the AND matrix is programmed, while the OR matrix is fixed. A further look at figure 3 shows that an intact fusible link may correspond to a logic high or low.

PAL devices are available in numerous variant forms:

- number of inputs — 8, 10, 12, 14, 16, 18, or 20;
- number of outputs — 2, 4, 6, 8, or 10;
- buffered outputs — feedback to inputs possible;
- programmable inputs and outputs;
- arithmetical functions.

Furthermore, it should be noted that PAL devices can be actuated with a normal PROM programmer.

PAL is a registered trademark of Monolithic Memories of the USA.

matrix = array

CPU = central processing unit

RAM = random access memory

EPROM = erasable programmable read-only memory

PIA = peripheral interface adapter

PIO = parallel input output

## A PAL for every application

1

Table 1 lists a number of current PAL devices of which the logic symbols are given in figure 5. The part number of these devices also defines their logic operation; it consists of the acronym PAL, followed by the number of array inputs, the output type (see below), the number of outputs, the speed and/or power, the temperature range, and the type of package.

The output types are:

- H — active high;
- L — active low;
- C — complementary, i.e., active at either logic level;
- R — registered, i.e., logic level may be retained with a bistable and fed back to the programmable AND matrix;
- X — exclusive OR registered;
- A — arithmetic registered.

Figure 4a shows the simplified structure of an L type PAL with one input and the corresponding output. Figure 4b shows a simplified structure in which the output is fed back to a point on the matrix where it

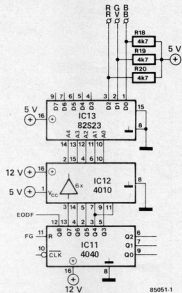
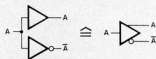

Figure 1. This illustrates the use of a bipolar PROM for the coding of an RGB signal.

### Logic symbols

A number of logic symbols are used in this article, which are neither accepted by the British Standards Institute, the American National Standards Institute, and the International Electrotechnical Commission, nor standardized throughout the electronics industry. None the less, they have been informally adopted by many IC manufacturers, because they show a clear relation between the chip layout and the logic diagram.



An input signal is always applied to two buffers which make the non-inverted as well as the inverted signal available at their respective outputs. To simplify this, the two buffers in PAL symbology are drawn as a single buffer with two outputs as shown above.

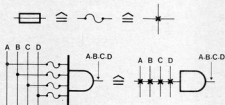

Logic gates and their numerous matrix-shaped inputs are also drawn in a simplified manner. Intact fuses are represented by crosses at the crossings of the relevant lines.

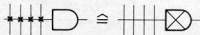

As long as all the fusible links of a gate are intact, they are not shown separately, but instead a cross is drawn in the gate symbol itself. The output of such a gate is always logic low.

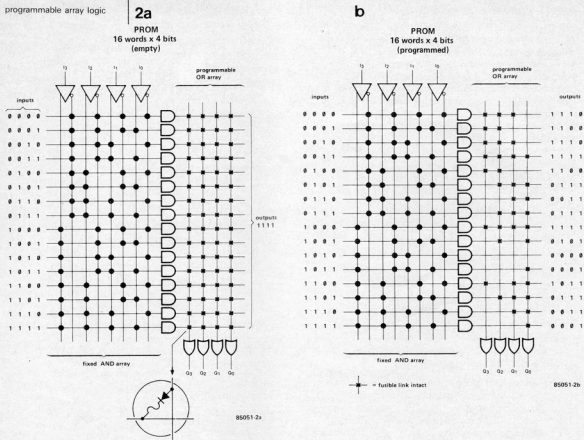

Figure 2a. A PROM consists of a fixed AND array and a programmable OR array; when all fusible links are intact, all outputs are logic high.

Figure 2b. When a fusible link is blown, the relevant output becomes logic low. The inputs are addresses, the outputs are data.

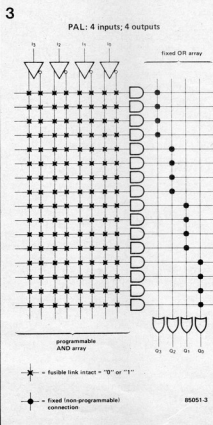

Figure 3. In contrast to a PROM, a PAL consists of a programmable AND array and a fixed OR array.

is converted into an input. This facility is of interest in the design of a shift register or a data loop. When the output inverter is switched over to high impedance, the output line can be used as an input.

The output of an R type PAL in figure 4c is buffered by a bistable and fed back to the matrix. The feedback allows the PAL to remember the previous state and it can alter its function based upon that state. The Q output of the bistable may be gated to the output pin by enabling the active low three-state inverter. This inverter can be switched to high impedance via a line common to all outputs.

Figure 4d shows how the sum of products is XORed at the input of the D type bistable. This function is of interest in the HOLD operation of counters.

Arithmetic functions are executed by gated feedback to the XOR device as shown in figure 4e. This set-up makes possible the combinations  $I+Q$ ,  $I+\bar{Q}$ ,  $I+Q$ , and  $I+Q$  which are fed to the matrix. This arrangement enables a sharp reduction (about 12 to 1) in the number of components as compared with standard logic circuits.

### First steps

An example of simple programming is illustrated in figure 6: (a) shows a circuit that is required to be replaced by a PAL device; (b) is a virgin PAL device chosen

Table 1.

PAL type	inputs (I)	outputs (Q)	programmable I/Os	registers	functions
10H8	10	8			AND-OR
12H6	12	6			AND-OR
14H4	14	4			AND-OR
16H2	16	2			AND-OR
10L8	10	8			AND-OR-INVERT
12L6	12	6			AND-OR-INVERT
14L4	14	4			AND-OR-INVERT
16L2	16	2			AND-OR-INVERT
16C1	16	1			AND-OR/AND-OR-INVERT
16L8	10	8	6		AND-OR-INVERT
16R8	8	8			AND-OR-INVERT-REGISTER
16R6	8	8	2	6	AND-OR-INVERT-REGISTER
16R4	8	8	4	4	AND-OR-INVERT-REGISTER
16X4	8	8	4	4	AND-OR-INVERT-XOR-REGISTER
16A4	8	8	4	4	AND-CARRY-OR-XOR-INVERT-REGISTER

4

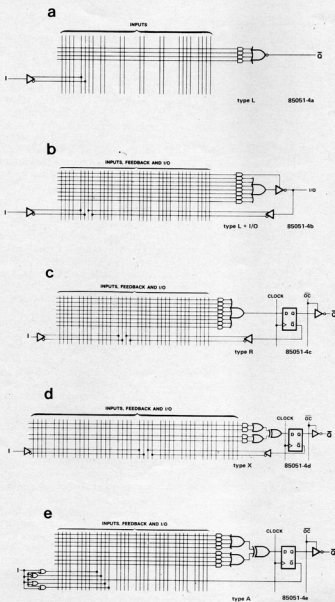

Figure 4. This illustrates the five different types of PAL; for simplicity's sake, only one input and one output are shown.

5

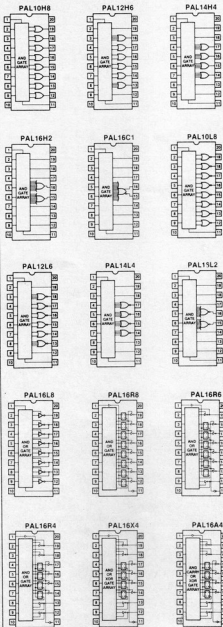

Figure 5. Logic symbols of fifteen current types of PAL.

6a

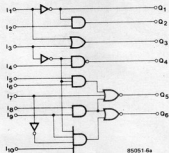

Figure 6. A logic circuit that is to be replaced by a PAL device.

as described below; and (c) is the programmed PAL.

As more than half the output signals are inverted, an L type is indicated. To obtain ten inputs and six outputs, the choice should fall on a type 10L8, but figure 5 shows that not one of the NOR gates in this type has more than two inputs. A further look at figure 5 shows that the type 12L6 has two NOR gates, each with four inputs. Since one of the outputs in figure 6a, Q5, is a combination of three signals, the type 12L6 is suitable for our purpose. The outputs in figure 6a may be defined, according to De Morgan's Theorem, as follows:

$$\begin{aligned}
 Q1 &= \overline{I1} & \hat{Q1} &= \overline{I1} = 11 \\
 Q2 &= \overline{I1} \cdot \overline{I2} & \hat{Q2} &= \overline{I1 + I2} \\
 Q3 &= \overline{I1} \cdot \overline{I3} & \hat{Q3} &= \overline{I1 + I3} \\
 Q4 &= \overline{I3} \cdot \overline{I4} & \hat{Q4} &= \overline{I3 + I4} \\
 Q5 &= \overline{I3} \cdot \overline{I5} \cdot \overline{I6} + \overline{I7} + \overline{I8} \cdot \overline{I9} \\
 & \hat{Q5} & &= \overline{I3 + I5 + I6 + I7 + I8 + I9} \\
 Q6 &= \overline{I8} \cdot \overline{I9} + \overline{I3} \cdot \overline{I7} \cdot \overline{I9} + \overline{I10} \\
 & \hat{Q6} & &= \overline{I8 + I9 + I3 + I7 + I9 + I10}
 \end{aligned}$$

As stated, the PAL type 12L6 shown in figure 6b, has all its fusible links intact. To effect that  $Q1 = \overline{I1}$  and  $\hat{Q1} = 11$ , the three unused inputs of NOR gate N1 in figure 6c must be logic 0: the fusible links on lines 9, 10, and 11, therefore, remain intact. On line 8, only the link with line 2 remains: all other links are blown. Output Q2 combines I1 and I2, but because it is inverting, the result is  $\hat{Q2} = I1 + I2$ . Only the links which connect the inputs of NOR gate N2 to columns 1 and 2 are retained; i.e., the inverting output of I1 and the non-inverting output of I2.

For Q3, only the input line of AND gate N3 to which the non-inverting outputs of I1 and I3 are connected is needed.

The coding of Q4, Q5, and Q6 is left to your own ingenuity: it is good practice! The results are shown in figure 6c in any case.

Another example concerns the replacement by a PAL of the logic functions shown in figure 7a. As you see, it concerns an inverter, an AND, OR, NOR, and XOR gate, and a NAND gate with three inputs. That gives a total of twelve inputs and six outputs which are active high. From the logic symbols in figure 5, it is easily seen that a 12H6 is required. When that type is programmed properly, the fuse pattern of figure 7b will ensue.

### Programming

The programming voltage should be  $11.5 \text{ V} \pm 0.5 \text{ V}$ , while the programming pulses should have a width of  $10 \dots 50 \mu\text{s}$ . To make it possible for the fusible links to be arranged in turn, the matrix has been divided into two groups: one for the links on lines 0...31, and the other for lines 32...63. In matrix columns 1...31 selection takes place with the aid of signals A0...A2 and O0...O3. The connections to the IC are dependent on whether the first or the second group of lines is being addressed. Tables 2 and 3 show how the



6b

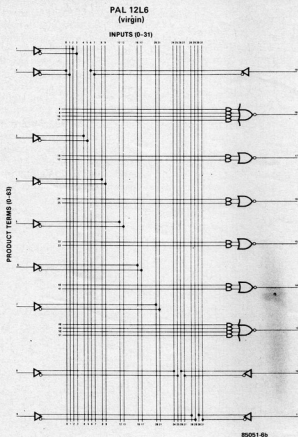

programmable array logic

Figure 6b. Logic diagram of a virgin PAL type 12L6 that is suitable for replacing the circuit of figure 6a.

6c

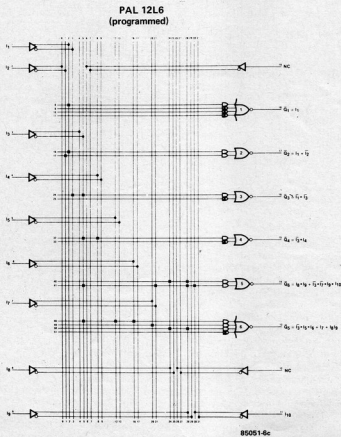

Figure 6c. Fuse pattern of the 12L6 after it has been programmed in accordance with the requirements of figure 6a.

## 7a

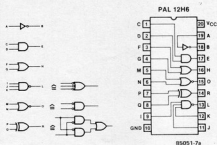

Figure 7a. Another example of a PAL device replacing a number of standard logic functions.

form. There is a special program available for this: PALASM (PAL assembler), written in FORTRAN IV, that translates the logic equation to a PAL fuse pattern. This software has been designed by Monolithic Memories. Unless you use it often, it may not be worth your while obtaining it, although making fuse patterns without it will not be easy, particularly when you first start.

The *PAL Databook* published by National Semiconductor gives programming tables for the fifteen PALs National produce. Apart from this book, the *PAL Handbook* published by Monolithic Memories is also strongly recommended. The more you

## 7b

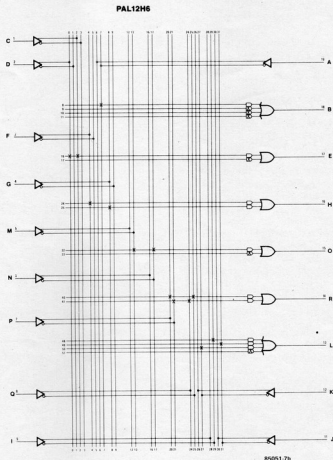

Figure 7b. Fuse pattern of the 12H6 after it has been programmed in accordance with the requirements of figure 7a.

addressing should take place, while figure 8 gives the connections for both groups. Figure 9 gives the timing diagram which also shows the programming and verify voltages. It does happen from time to time that certain links refuse to be blown; in that case, reprogramming after testing is necessary, and may be necessary again. It cannot be pretended that every retailer is able to program PAL devices, even if he stocks them, but there are some! You have to draw a matrix as shown in figures 6b and 7b (but, of course, relevant to your particular device!) and convert that into a code that is acceptable to the programmer. That means that the addresses and data must be converted into hexadecimal

become engrossed in PALs, the more they will grip you!

## Literature:

*PAL Handbook*  
Monolithic Memories Ltd  
Monolithic House  
1 Queens Road  
Farnborough  
Hants GU14 6DJ  
Telephone: (0252) 517431

*PAL Databook*  
National Semiconductor (UK) Ltd  
301 Harpur Centre  
Home Lane  
Bedford  
Telephone: (0234) 47147

Table 2.

input line number	pin identification									L/R
	I <sub>7</sub>	I <sub>6</sub>	I <sub>5</sub>	I <sub>4</sub>	I <sub>3</sub>	I <sub>2</sub>	I <sub>1</sub>	I <sub>0</sub>		
0	HH	HH	HH	HH	HH	HH	HH	L	R	
1	HH	HH	HH	HH	HH	HH	HH	H	R	
2	HH	HH	HH	HH	HH	HH	HH	L	HH	
3	HH	HH	HH	HH	HH	HH	HH	H	HH	
4	HH	HH	HH	HH	HH	HH	L	HH	R	
5	HH	HH	HH	HH	HH	HH	H	HH	R	
6	HH	HH	HH	HH	HH	HH	L	HH	HH	
7	HH	HH	HH	HH	HH	HH	H	HH	HH	
8	HH	HH	HH	HH	HH	L	HH	HH	R	
9	HH	HH	HH	HH	HH	H	HH	HH	R	
10	HH	HH	HH	HH	HH	L	HH	HH	HH	
11	HH	HH	HH	HH	HH	H	HH	HH	HH	
12	HH	HH	HH	HH	L	HH	HH	HH	R	
13	HH	HH	HH	HH	H	HH	HH	HH	R	
14	HH	HH	HH	HH	L	HH	HH	HH	HH	
15	HH	HH	HH	HH	H	HH	HH	HH	HH	
16	HH	HH	HH	L	HH	HH	HH	HH	R	
17	HH	HH	HH	H	HH	HH	HH	HH	R	
18	HH	HH	HH	L	HH	HH	HH	HH	HH	
19	HH	HH	HH	H	HH	HH	HH	HH	HH	
20	HH	HH	L	HH	HH	HH	HH	HH	R	
21	HH	HH	H	HH	HH	HH	HH	HH	R	
22	HH	HH	L	HH	HH	HH	HH	HH	HH	
23	HH	HH	H	HH	HH	HH	HH	HH	HH	
24	HH	L	HH	HH	HH	HH	HH	HH	R	
25	H	L	HH	HH	HH	HH	HH	HH	R	
26	HH	L	HH	HH	HH	HH	HH	HH	HH	
27	HH	H	HH	HH	HH	HH	HH	HH	HH	
28	L	HH	HH	HH	HH	HH	HH	HH	R	
29	H	HH	HH	HH	HH	HH	HH	HH	R	
30	L	HH	HH	HH	HH	HH	HH	HH	HH	
31	H	HH	HH	HH	HH	HH	HH	HH	HH	

Table 3.

product line number	pin identification						
	O <sub>3</sub>	O <sub>2</sub>	O <sub>1</sub>	O <sub>0</sub>	A <sub>2</sub>	A <sub>1</sub>	A <sub>0</sub>
0.32	R	R	R	VPH	R	R	R
1.33	R	R	R	VPH	R	R	HH
2.34	R	R	R	VPH	R	HH	R
3.35	R	R	R	VPH	R	HH	HH
4.36	R	R	R	VPH	HH	R	R
5.37	R	R	R	VPH	HH	R	HH
6.38	R	R	R	VPH	HH	HH	R
7.39	R	R	R	VPH	HH	HH	HH
8.40	R	R	VPH	R	R	R	R
9.41	R	R	VPH	R	R	R	HH
10.42	R	R	VPH	R	HH	R	R
11.43	R	R	VPH	R	R	HH	HH
12.44	R	R	VPH	R	HH	R	R
13.45	R	R	VPH	R	HH	R	HH
14.46	R	R	VPH	R	HH	HH	R
15.47	R	R	VPH	R	HH	HH	HH
16.48	R	VPH	R	R	R	R	R
17.49	R	VPH	R	R	R	R	HH
18.50	R	VPH	R	R	R	HH	R
19.51	R	VPH	R	R	R	HH	HH
20.52	R	VPH	R	R	HH	R	R
21.53	R	VPH	R	R	HH	R	HH
22.54	R	VPH	R	R	HH	HH	R
23.55	R	VPH	R	R	HH	HH	HH
24.56	VPH	R	R	R	R	R	R
25.57	VPH	R	R	R	R	R	HH
26.58	VPH	R	R	R	R	HH	R
27.59	VPH	R	R	R	R	HH	HH
28.60	VPH	R	R	R	HH	R	R
29.61	VPH	R	R	R	HH	R	HH
30.62	VPH	R	R	R	HH	HH	R
31.63	VPH	R	R	R	HH	HH	HH

L = Low-level input voltage, (V<sub>IL</sub>)  
 H = High-level input voltage (V<sub>IH</sub>)  
 HH = High-level program voltage, (V<sub>IHH</sub>)  
 R = 10 k Ohms to 5.0 V  
 VPH = Programming Pulse

programmable array logic

8

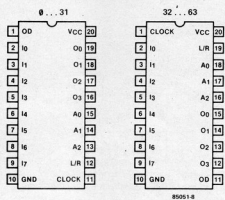

Figure 8. During the programming of a PAL device, the connections depend on the group of lines that are being programmed.

9

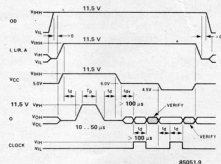

Figure 9. Timing diagram complete with test (verify) voltages.

The 7106 is a well known IC in the world of A/D converters, and was chosen for three main reasons. Firstly this IC is a 'jack of all trades' and is widely used in all forms of voltage or temperature measuring instruments. Secondly, because it is universally available and relatively inexpensive. Last but not least, the 7106 and its big brother (7116), have so many functions already integrated within themselves that only a few passive components and a LCD are needed to complete a good circuit. The 7106 contains an A/D converter, clock generator, reference voltage

dependant upon the time. In turn the contents of the counter are then displayed on the LCD. The advantage of using this method is that a relatively simple and straightforward oscillator can be applied. The oscillator frequency of the IC is in fact determined by the values of R2 and C3. This frequency also determines the number of 'samples' taken in every second. As a matter of interest, using the values as indicated in the circuit diagram, three samples are taken every second.

The IC ensures a zero setting before each 'sample', or measurement, automatically. Quite simply, the inputs are

# L.C.D. thermometer

... accurate to 0.1 of a degree

source, BCD-to-seven-segment decoders, and latch and display drivers! Quite a bundle of energy! And even if this array of goodies was not enough, it is also equipped with an automatic zero correction, and polarity indication. The 7116 (believe it or not), not only has everything the 7106 has to offer, but also includes a hold facility enabling the read-out to be frozen, if required.

The circuit described here is

first of all decoupled internally from the actual input pins and then short circuited. The automatic zero capacitor (C5 in this case) is charged via a separate feedback loop, so that the offset voltages of the buffer amplifier, integrator, and comparator are compensated for, inside the IC. This guarantees any measurement really does start from 0 V, and that when the display reads 000, it does denote a 0 input voltage.

The temperature measurement stage is straightforward if somewhat sophisticated. It contains three voltage dividers: R10 and R11; R8/P1; R9/P2. The junction of the first divider containing the sensor R11 is connected to the 'IN HI' input of the IC. The wiper of potentiometer P1 is linked to the 'IN LO' input and the wiper of P2 to the 'REF HI' input. In effect the circuit measures the differential voltage between one side of the sensor and the wiper of P1. Any measurement is completely independent of the supply voltage level, because the reference voltage of the IC is also derived from the supply (via the divider R9/P2).

Keep in mind that a full scale readout will be equal to twice the reference voltage. Any decrease in supply voltage will not change the readout, because the reference voltage will decrease by the same amount (when compared with the measuring voltage that is). Resistor R4 and capacitor C6 act as an input smoothing filter.

The display is driven directly by the IC. The EXOR gate N2 ensures that the decimal point is activated, by supplying the inverted backplane signal to the corresponding LCD points.

The circuit also has a low battery indication function. The display denotes this by either an arrow or the term 'Low Bat'. An EXOR gate also controls this function!

Transistor T1 is used as a supply voltage level detector. The emitter is connected to the junction of R5 and R7, and its base to the test connection of the IC. This pin not only allows the display

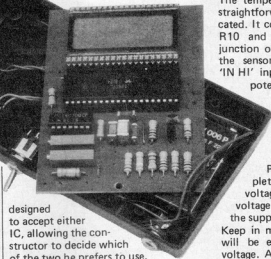

designed to accept either IC, allowing the constructor to decide which of the two he prefers to use.

## The circuit diagram

The circuit as shown in figure 1 is really nothing more than a digital voltmeter, which in turn measures the voltage drop across a temperature sensor.

The dual slope conversion principle is applied for the voltage measurement. Basically the input voltage from the sensor charges capacitor C4 for a fixed period of time. The capacitor then discharges, the rate at which the capacitor is discharged being determined by the reference voltage. The actual time it takes for the capacitor to discharge fully (return to zero) is then proportional to the input voltage level. During the discharge period, pulses from an oscillator are stored in a counter, obviously the number of pulses

During the past few months, the Elektor offices have been inundated with requests for a digital thermometer.

In answer to all these requests, and to relieve the pressure on our technical queries department, we present a digital circuit using a special IC and a LCD display. The design is inexpensive, but, nevertheless accurate, precise, and has a very low power consumption! The range of the instrument is from  $-50^{\circ}\text{C}$  to  $+150^{\circ}\text{C}$ . The temperature is displayed 0.1 degree at a time, therefore making it suitable for practically any application.

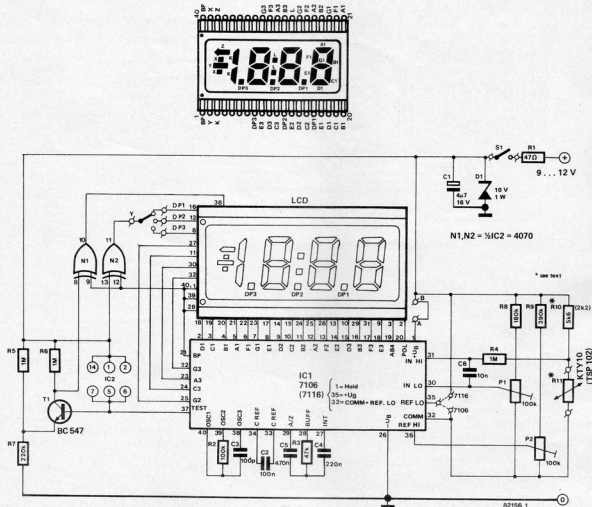

Figure 1. The circuit diagram of the digital thermometer. The circuit is compact, consisting of two ICs and a few surrounding components. A 9 V battery supply is ideal.

itself to be tested (by connecting it to a +5 V supply), but, moreover can provide us with a positive stabilised d.c. voltage! By choosing the right ratio between R5 and R7, T1 will cutoff the moment the supply voltage drops below 7.2 V. As a result the collector voltage of T2 increases, causing N1 to activate the correct notation on the display.

A 9 V battery such as a PP3 is quite sufficient, since the circuit consumes only a few milli-amps. A mains supply is also possible, and it is for this reason that R1 and the zener D1 are added to the circuit.

### The temperature sensor

There are various types of sensors on the market, and the only reason we have picked two particular ones, is that they are inexpensive.

Original tests showed the KTY 10 from Siemens to be ideal, but, as this can be difficult to get hold of, we also tried

the TSP 102 manufactured by Texas Instruments which worked well. Most of the types looked at consisted of a silicon plate, whose resistance depended on the temperature. The only real difference between types was their temperature range. The KTY10, for instance ranged from  $-50^{\circ}\text{C}$  to  $+150^{\circ}\text{C}$ , whereas the TSP was effective over a range from  $-55^{\circ}\text{C}$  to  $125^{\circ}\text{C}$ . The first version has a nominal resistance of  $2000\ \Omega$  at  $25^{\circ}\text{C}$  and the TSP  $1000\ \Omega$  again at  $25^{\circ}\text{C}$ . The temperature coefficient was  $0.75\%/^{\circ}\text{C}$  and  $0.7\%/^{\circ}\text{C}$  respectively. These last figures denoting the resistance increase, per degree celsius, as a percentage over the nominal value.

The accuracy of the circuit is mainly dependant on the width of the measuring range. Which type to use is left to the discretion of the constructor. A serial resistor (R10) is applied (in series with the sensor) in order to stabilise the linearity of the sensor, especially when small measuring ranges

are required. Table 2 provides a summary of several ranges, with the linearity error, and serial resistor values needed. Table 3 describes, in detail, the differing sensors, together with their housing dimensions and type numbers.

### Construction

Figure 2 illustrates the specially designed printed circuit board of the circuit.

The dimensions of the board and the way that the components have been grouped together allow the completed circuit to fit into a case manufactured by Vero (type Nr. 65-2996H). Provision has been made for all the components to be mounted onto the printed circuit board. Constructors should make sure that low profile sockets are used for IC1, IC2 and the display. The display can be inserted into a 40 pin socket which has been sawn in half. We also advise the use of good quality multi-turn presets. As with anything made of glass, great

2

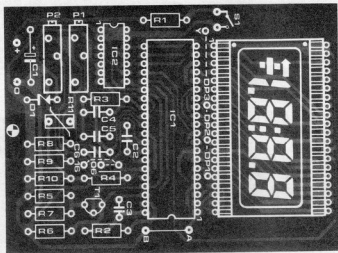
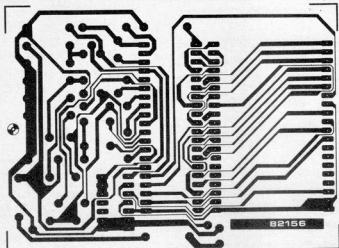

Figure 2. The track pattern and component layout of the printed circuit board. The size and layout of the board allows the completed circuit to be inserted into a ready made plastic case by Vero. Ensure the correct wire links are in place for the 7106 or 7116.

3

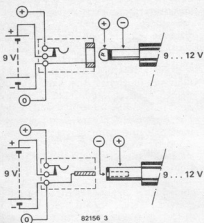

Figure 3. An external power supply can be connected as shown. The battery is automatically switched off when the plug is inserted.

care should be taken when handling the display, especially when inserting it into its socket. Too much pressure on the glass plates may cause the display to appear internally smudged, permanently!

When using the circuit as a normal thermometer, the decimal point DP1 should be connected to point Y by means of a wire link. Obviously, depending on the application, the decimal point can be moved around, by using a rotary or slide switch, if required.

As already stated earlier, the circuit is designed to take either the 7106 or the 7116. For the 7106 wire links are required across points A and B and 06, as shown on the component overlay illustration of the printed circuit board. In the case of the 7116, link 06 is removed and replaced with a link on points '16'. Should you then require the ability to freeze (hold) the display reading, link AB has to be replaced with a simple on/off press button switch.

## parts list

## Resistors:

- R1 = 47  $\Omega$
  - R2 = 100 k
  - R3 = 47 k
  - R4, R5, R6 = 1 M
  - R7 = 220 k
  - R8 = 180 k\*
  - R9 = 390 k\*
  - R10 = 5k6 (2k2)\*
  - R11 = KTY 10 (TSP102)
  - P1, P2 = 100 k multi-turn preset
- \* metal film is preferred

## Capacitors:

- C1 = 4 $\mu$ 7/16 V
- C2 = 100 n
- C3 = 100 p
- C4 = 220 n
- C5 = 470 n
- C6 = 10 n

## Semiconductors:

- T1 = BC547
  - D1 = zenerdiode 10 V/1 W
  - IC1 = 7106, 7116
  - IC2 = 4070
- LCD: 3 $\frac{1}{2}$  digit-type, for example  
Hamlin 3901 or 3902  
Hitachi LS007C-C or H1331C-C  
Norsem NDP 530-035A S-RF-P1

## Miscellaneous:

- S1 = single pole switch
  - S2 = single pole switch or key for hold function (only for 7116)
- battery clip for 9 V battery  
housing: Vero, type 65-2996H

For components contact

VISHA ELECTRONICS

349, Lamington Road,

Bombay 400 007. Tel: 362650.

Keep in mind that this facility is not available when using the 7106.

The sensor can be connected to the circuit by means of ordinary insulated wire, the length of which is not critical. In fact anything up to 30 metres is possible without difficulty. For reliability we suggest encapsulating the soldered connections of the sensor with epoxy resin or glue.

A PP3 type 9 V battery is ideal for the power supply, as it has the advantage of fitting nicely into the battery compartment of the Vero case.

Constructors wishing to feed the circuit from the mains, can install a miniature supply socket next to the battery, to cater for a 9 V mains adapter. Figure 3 clearly illustrates how this should be wired. The battery supply will be automatically cut off immediately a power plug is inserted.

A single bolt or screw with a spacer ensures the circuit is firmly fixed into the case. A piece of clear perspex in the window of the case will protect the

Table 1

Nominal resistance value of the several types

new indication KTY10

suffix	resistance value at 25°C	old indication KTY10, KTY11-1, KTY11-2
-3	1910 Ω ± 1%	A 2000 Ω ± 1%
-4	1940 Ω ± 1%	B 2000 Ω ± 2%
-5	1970 Ω ± 1%	C 2000 Ω ± 5%
-6	2000 Ω ± 1%	D 2000 Ω ± 10%
-7	2030 Ω ± 1%	
-8	2060 Ω ± 1%	
-9	2090 Ω ± 1%	

TSP102, TSF102, TSU102

suffix	resistance value at 25°C
F	1000 Ω ± 1%
G	1000 Ω ± 2%
J	1000 Ω ± 5%
K	1000 Ω ± 10%

Table 3

Housings of the several types

KTY10, TSP102

The housing most frequently used. The setting time is 30 s to 63% of the final value and 150 s upto 99% in silent air.

Housing A

KTY11-1, TSF102

This is a smaller version with screw connection. The settleable time is 7 s to reach 63% of the final value.

Housing B

KTY11-2, TSU102

The same case as housing B, but without screw fastening

Housing C



Table 2

Serial resistance for KTY sensors

temp. range	R <sub>series</sub>	lin. error
-20 ... +40°C	5k6	+0,08 ... -0,04°C
+40 ... +100°C	8k2	+0,03 ... -0,02°C
+60 ... +140°C	10k	+0,07 ... -0,04°C
-20 ... +130°C	6k8	+0,6 ... -0,6°C
-50 ... +150°C	6k8	+1 ... -1°C

Serial resistance for TS ... 102 sensors

temp. range	R <sub>series</sub>	lin. error
-25 ... +45°C	2k2	---
0 ... +100°C	2k6	+0,05 ... -0,07°C
-55 ... +125°C	2k5	+0,3 ... -0,2°C

display. The switches, sockets and so forth can be mounted in the power part of the housing.

The current consumption of the circuit when using the most commonly available sensor (TSP102) is only 2 mA.

Several sensors, which are activated consecutively by a separate switch can also be used. To do this correctly, sensors have to be selected for equality, otherwise errors in measurement readings will occur.

### Calibration

Perhaps we have been a little too quick to explain how to install the circuit into the case, because first of all it has to be calibrated.

Initially the sensor has to be placed into a small cup of chopped melting ice. The cup should contain more ice than water, and the water must cover the ice completely. Give the sensor time to react (about 5 minutes), and turn P1 until the display reads 00.0. P2 sets the scale factor. How this is adjusted depends on the measuring range required. For lower temperatures (-25°C to +45°C), P2 can best be calibrated using a normal thermometer. Insert both thermometers into a bowl of water having a temperature of around 36 ... 38°C, give the sensor a little time to react, and then set P2 so that the reading on the display corresponds.

Higher measuring ranges can be calibrated by suspending the sensor in boiling water, and then adjusting P2 until the readout is 100°C. The only critical aspects of this procedure are to ensure that the water really is boiling and that the sensor does not touch the sides, or bottom of the kettle.

Finally as you have completed the circuit, why waste the hot water. Make a nice cup of tea and relax. 

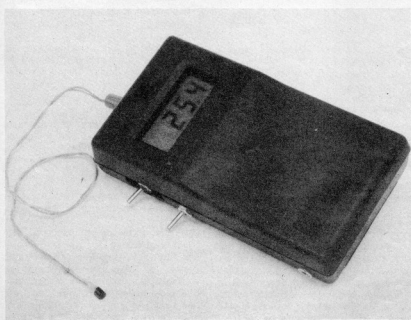

# temperature-to-voltage converter

This circuit provides a simple means of constructing an electronic thermometer that will operate over the range 0 to 24°C (32 to 75°F). The circuit produces an output of approximately 500 mV/°C, which can be read off on a voltmeter suitably calibrated in degrees.

In order that the circuit should be kept simple the temperature sensing element is a negative temperature coefficient thermistor (NTC). This has the advantage that the temperature coefficient of resistance is fairly large, but unfortunately it has the disadvantage that the temperature coefficient is not constant and the temperature-voltage output of the circuit is thus non-linear. However, over the range 0 to 24°C the linearity is sufficiently good for a simple thermometer.

Op-amp IC1 is connected as a differential amplifier whose inputs are fed from a bridge circuit consisting of R1 to R4. R1, R2, R3 and R4 form the fixed arms of the bridge, while R4 forms the variable arm. The voltage at the junction of R1 and R2 is about 3.4 volts. With the NTC at 0°C P1 is adjusted so that the output from the op-amp is zero, when the voltage at the junction of R3 and R4 will also be 3.4 V. With increasing temperature the resistance of the NTC decreases and the voltage across it falls, so the output of the op-amp increases. If the output is not exactly 0.5 V/°C then the values of R8 and R9 may be increased or

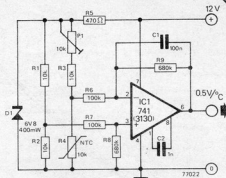

decreased accordingly, but they should both be the same value.

The IC can be a general purpose op-amp such as a 741, 3130 or 3140. The compensation capacitor C2 is not required if a 741 is used since this IC is internally compensated. Almost any 10k NTC thermistor may be used for R4, but the smaller types will obviously give a faster response since they have a lower thermal inertia. 5k or the 15k types could also be used, but the values of P1 and R3 would have to be altered in proportion.

# multi-purpose time switch

Using two CMOS counters it is a simple matter to construct a versatile time switch. The total cycle time of the switch can be set between zero and 93.2 hours, and the time switch can be made to switch equipment on and off at any time during this cycle.

The reference frequency for the timer is the 50 Hz mains frequency. Two 4040 counters are connected in cascade and count the 50 Hz pulses. Each of these ICs is a 12-bit counter, so the maximum time that the counters will count to is 0.02 x 2<sup>24</sup> seconds, where 0.02 seconds is the period of the mains waveform. This is equal to 93.206

hours. If a shorter cycle time is required it is necessary that the counters be reset when the required count is reached. As an example suppose that the desired cycle time is 24 hours. The counter must therefore count up to 24 x 60 x 60 x 50 = 432000, which in binary is 10000111010110000000. Where a 1 occurs in this number the corresponding counter output is connected to one of the inputs of the diode AND gate D6 to D13. When the desired count is reached these outputs will all be high simultaneously and monostable N1/N7 will be triggered, giving

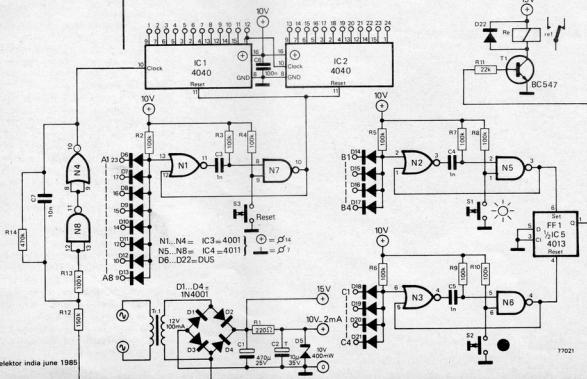



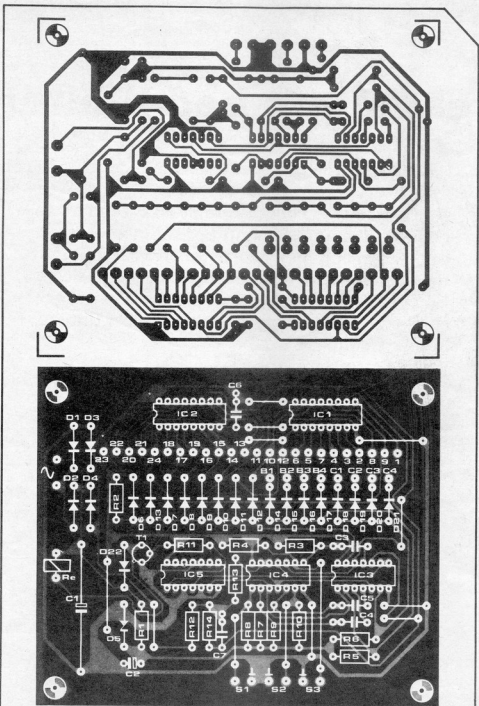

the counter a reset pulse.

A manual reset button is also provided. Any other desired cycle time up to the previously mentioned maximum may also be accommodated, but obviously some counts will require more or less diodes in the AND gate. The switch-on and switch-off times of the equipment to be controlled are also determined in the same manner. The binary equivalents of the on and off times are calculated and the appropriate counter outputs are connected to AND gate inputs B1 to B4 for switch-on and C1 to C4 for switch-off. At switch-on monostable N2/N5 is triggered, which sets flip-flop FF1, turning on T1 to activate the relay. At switch-off monostable N3/N6 is triggered, which resets FF1. Manual controls are also provided. If several circuits are to be controlled with

different switch-on and switch-off times then N2, N3, N5, N6, FF1 and T1 may be duplicated.

The one disadvantage of this circuit is that initially it must be reset at the time that the timing cycle is required to start, i.e. there is no time-setting facility, so in the event of a power failure it would be necessary to wait until the correct start time before resetting the circuit. For this reason it is best to make the start of the timing sequence occur at a convenient moment, such as in the morning or early evening.

To make the clock input of the counter less susceptible to interference pulses on the mains waveform it may be a good idea to precede it by a Schmitt-trigger using two CMOS NAND gates

# reading-in-bed limiter

At a certain age, children are often packed off to bed with the final admonition: 'All right, you can read in bed for a quarter of an hour, but then you must turn off the light and go to sleep'. However as most parents will know, the children tend to suddenly loose all sense of time in this situation . . .

When a member of the Elektor design team was faced with this problem, he started looking for an electronic solution. The final circuit, as published here, has proved extremely effective.

1

Figure 1. Complete circuit of the reading-in-bed limiter. S1 must be a key-switch that can only be operated by the parents.

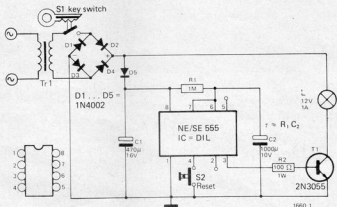

1660 1

In the situation outlined above, what is really required is a unit that will automatically turn off the bedside reading lamp after the specified time has elapsed. This time switch must have a few special features:

- It should only be possible for the parent(s) to switch on the lamp. This can be achieved by using a key switch.

It should be possible for the child to turn off the lamp before the allotted time has elapsed, if it finds that it is getting too sleepy to read. Since the child hasn't got the key to the main switch, a further reset button is required.

For safety reasons, it is essential to use a low-voltage lamp. The whole circuit, including the lamp, should be run off a reliable mains transformer. Since they are easy to obtain, a logical choice is to use a 12 V lamp as used in cars.

### The circuit

The obvious choice for the timer itself is the 555 timer IC, since this can be set to give delay times up to several hours with complete reliability. Furthermore, the obvious transistor type to use for switching the lamp is the well-known 'work-horse' the 2N3055. Having chosen these two components, the circuit design is almost finished! The complete circuit is shown in figure 1.

The IC is used as a monostable multivibrator (MMV). The duration of the output pulse is set by a single RC-network, R1 and C2. In this particular application, the pulse duration is practically equal to the RC time. If R1 is 1 M and C2 is 1000  $\mu$ , as shown, the RC time is 1000 seconds, or just over a quarter of an hour. Note that any leakage in C2 will extend this time appreciably; for this reason it is advisable to use a tantalum electrolytic, and not to increase the value of R1 any further.

Initially, C2 is discharged. When the circuit is switched on via the key-switch S1, C2 starts to charge through R1. During this time, the output of the IC (pin 3) is at positive supply level. This turns on transistor T1, lighting the lamp. R2 limits the base current to the transistor. With the type of lamp shown (12 V, 10 . . . 15 W), the dissipation in T1 should be so low that a heat sink is not required. The supply to the lamp is the raw, full-wave rectified supply voltage. There is nothing to be gained by smoothing this supply.

An extra diode (D5) and a relatively small smoothing capacitor (C1) are used for the supply to the IC.

When the RC-time has elapsed, the output of the IC switches to 0 V, turning off T1 and the lamp. Pushing the reset button (S2) will switch the lamp off sooner. Since the 'set' input (pin 2) is

not used, the only way to switch the lamp on again is to first turn the supply off, wait until C2 has discharged, and then switch on again. Officially, this should be done with the key-switch. It is not advisable to demonstrate even once that the same effect can be produced by pulling out the mains plug for a short time . . .

A printed circuit board layout for the unit is shown in figure 2.

Note that sufficient care should be taken with the mains connection. Use good cable, a rubber grommet where the cable enters the box, and some form of clamp over the cable just inside the box so that there is no 'pull' on the connection to the transformer.

M

Figure 2. Printed circuit board and component layout for the unit. T1 can be mounted on the board, since a heat-sink should not be necessary (EPS 1660).

2

#### Parts list:

##### Resistors:

R1 = 1 M  
R2 = 100  $\Omega$

##### Semiconductors:

IC = 555  
T1 = 2N3055  
D1 . . . D5 = 1N4001, BY126, etc.

##### Capacitors:

C1 = 470  $\mu$ /16 V  
C2 = 1000  $\mu$ /10 V

##### Sundries:

S1 = key switch  
S2 = reset push button  
L = 12 V/1 A lamp  
Tr1 = transformer, 12 V/1 A

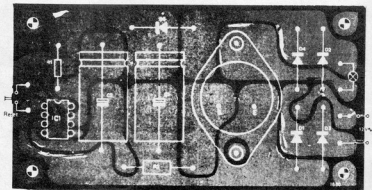
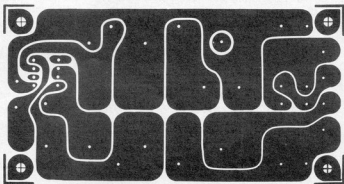

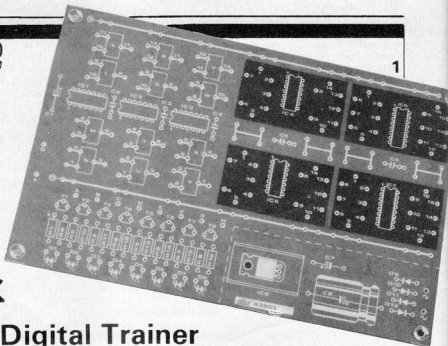

## Digilex

### Inexpensive Digital Trainer

Eventhough it is possible to decipher the functions of digital circuits with paper and pencil, it is much more exciting to try out the circuits in actual practice. And to bring you the excitement, we have put together a digital experimenting system, namely the Digilex-Board. This has been designed in such a way that no soldering work is required while trying out the experiments. The circuit can be hooked up in a minute and tested. Digilex is conceived as a supplement to our Digi-Course. The experimental instructions refer to this system. Naturally, all other possible circuits can also be tested on this board.

Digilex-Board has place for five 14 pin and two 16 pin ICs of the inexpensive TTL series. IC sockets are soldered on the board, instead of directly soldering the ICs, so that different ICs can be tried out. The ICs listed in the component list provide for eight NAND gates and four NOR gates. (The meaning of NAND and NOR is explained in the Digi-Course.)

All the input/outputs of the ICs, except for the voltage supply connections, are brought to the pins through copper tracks. The pins are soldered on the PCB, and the experiments are connected with wire bridges having plug sockets soldered at the ends. These plug

sockets fit onto the pins soldered on the PCB. Eight LEDs are provided for indicating the individual logic states during the experiments.

Power supply to the board can be given in three different ways.

1. With a 4.5 V battery. Although the rated operating voltage of the TTL-series ICs is 5 Volts, even 4.5 V can be used. The battery supply can be directly given at the plus and minus connections on the board.

2. With the help of power supply circuit on the Digilex-Board. In this case, a 9 V transformer forms the source of power. The transformer must be properly housed in a casing with good insulation from the mains connection. The power supply circuit on the board rectifies the 9 V AC voltage from the transformer and stabilises it to 5 V DC.

3. With a 9 V unregulated battery eliminator. The 9 V DC output of the battery eliminator can be connected to the input of the stabiliser circuit on the board; consisting of capacitors C7 and C8 along with the stabiliser IC 8. The rectifier diodes D9 to D12 are not used in this case.

2

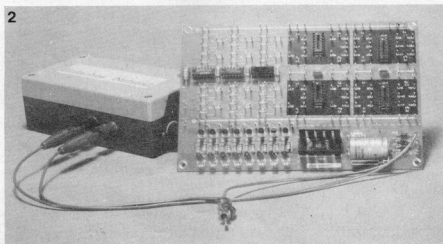

The assembly of the Digilex-Board is very simple. The resistors are soldered first, then the capacitors and then the semiconductors. While soldering the semiconductors and electrolytic capacitors, remember to keep the polarity correct. The voltage regulator IC 8 (7805) is fitted with a screw on the board, along with the heat sink. As the earthing pin of the IC (center pin) is internally connected to the cooling fin, care should be taken so that the other two pins do not touch the heatsink anywhere. Insulating sleeves can be used on these two pins for this purpose.

It is needless to say that only best quality hardware and components should be used to avoid problems in future.

In case of brand new ICs, the pins stand far apart from the desired spacing of the socket, and it is necessary to gently press the rows of pins towards the centerline of the IC to match with the socket dimensions. Also check that the marking on the IC is as per the orientation shown in the printed component layout on the board.

The wire used for the connecting bridges should be of the multi-strand type, so that it does not break quickly during use.

### The Circuit

Figure 5 shows only the essential features of the circuit of the Digilex-Board. The supply is connected to pins 14 (+) and pins 7 (-) of the ICs 1, 2 and 3, as well as the tracks marked (+) and (-).

All the eight indicator units consist respectively of a transistor, two resistors and an LED. Whenever there is a logic 1 (5 V) at the input A.....H, current flows through the 1 K ohm resistor into the base of the transistor and makes the transistor conductive. When the transistor conducts, current flows through the LED and the LED glows. The 180 ohms resistor limits the current through the LED. When there is logic 0 (0 V) at the input A.....H, no current flows and the LED does not glow. Capacitors C1 to C6 serve as noise suppressors and prevent any spurious triggering.

Diodes D9 to D12 form the rectifier bridge to convert the AC voltage from the transformer to DC voltage.

Capacitors C7 and C8 serve as filters to smooth out the rectified DC voltage and IC 8 provides a stabilised 5 V output., which is also short circuit protected.

When using the Digilex-Board, care should be taken not to connect any of the gate outputs either to ground or to 5 V supply line, and for the sake of safety, the power supply should be disconnected before plugging the ICs into the sockets.

### 3

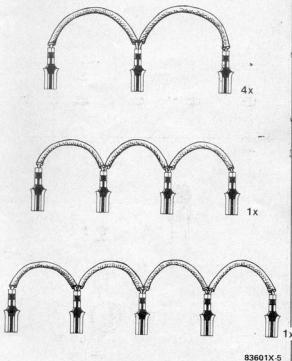

Suggestions for a variety of connecting bridges.

### 4

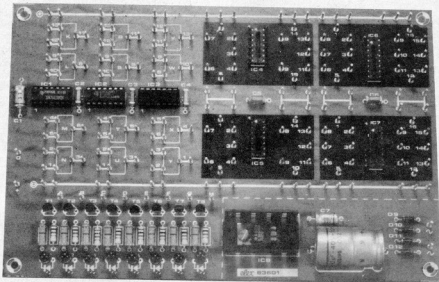

### Component List

- R1 to R8 = 180 $\Omega$   
 R9 to R16 = 1 k $\Omega$   
 C1 = 100  $\mu$ F/10 V  
 C2 to C6 = 100 nF  
 T1 to T8 = BC 547 or 147 B  
 D1 to D8 = Red LEDs  
 IC1, IC2 = 74LS00/7400  
 NAND X 4  
 IC3 = 74LS02/7402  
 NOR X 4
- 5 IC sockets—14 Pin  
 2 IC sockets—16 Pin  
 C7 = 10 $\mu$ F/10 V  
 C8 = 7805 (5 V regulator)  
 D9 to D12 = 1N4001  
 Transformer = 9 V, 0.5 A  
 Heat sink = 35 x 20 mm.

## 5

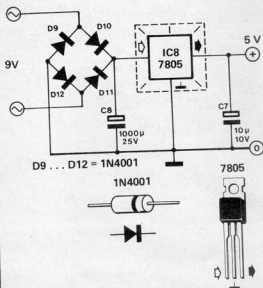
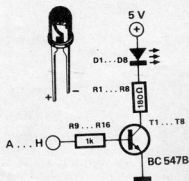
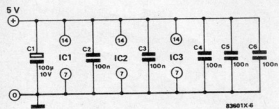

The circuit diagrams of the Digilex-Board. IC sockets are not shown, and only one indicator unit is shown out of the eight indicator units.

# Digi-Course

## Chapter 2

# NAND, NOR

Three basic operations of the binary system of numbers—namely the AND, OR and NOT operations were introduced in Chapter 1 of our Digi-Course. All these operations can be carried out by electronic circuits called gates. Figure 1 will help in refreshing our memory about these gates and their truth tables.

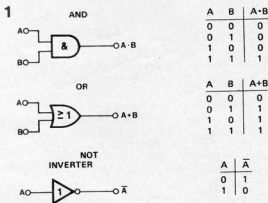

The truth table, as we have seen before, presents a precise picture of how the gate output behaves in response to different input combinations.

The symbols + and · used here have nothing to do with the usual addition and multiplication symbols. Here the symbol + stands for AND operation and the symbol · stands for OR operation. NOT operation is characterised by a horizontal bar.

The TTL gates process the binary numbers in form of voltage levels 0 V and 5 V. An OR gate produces a 5 V output in response to 5 V at least at one of the inputs. (see the second, third and fourth line of the OR truth table.) With the new Digilex-Board the truth table can be tested easily. But stop! The Digilex-Board has no AND, OR, NOT gates. What to do?

Possibility 1. : Purchase one AND gate IC, one OR gate IC and one NOT gate IC (see figure 9 for type specification) and use in place of the NAND gate IC on the Digilex-Board.

Possibility 2. : Check, if a NAND gate IC can also be used to create AND, OR, NOT functions?

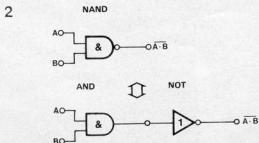

What is actually a NAND? "NAND" is the combination of NOT and AND; both in the verbatim sense as well as in the technical sense.

The truth table of the NAND operation can be derived from that of the AND operation.

Table 1.

A	B	AND		NAND	
		A · B	$\overline{A \cdot B}$		
0	0	0	1		
0	1	0	1		
1	0	0	1		
1	1	1	0		

Let us observe the last two lines carefully. In both the cases A is "1", B and the NAND-output  $\overline{A \cdot B}$  are exactly opposite of each other. In other words, when A is at 5 V, the NAND gate behaves as an inverter or the NOT gate. (Since the TTL gates interpret an unconnected input as "1", one need not bother about A at all. But this feature is seldom made use of in practice.) The same is true when B remains "1", the input A is then inverted. And finally when A and B both are identical, both are simultaneously inverted. This means that when A and B are physically tied together, the NAND gate behaves as an inverter or NOT gate.

### 3

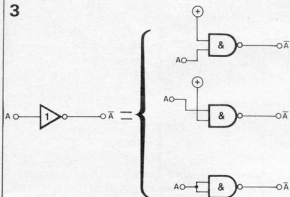

All the three possibilities can now be tried out on the Digilex-Board. A NAND-input is connected to + and the other input is alternately connected to + ("1") or 0 ("0"). The NAND-output is connected to the input of an indicator circuit. The LED indicates a logic "1" at the output when it glows.

We can now use this inverter obtained from the NAND gate. If a NAND gate is followed by an inverter, then both the NOT operations cancel each other and what remains is the AND gate.

### 5b

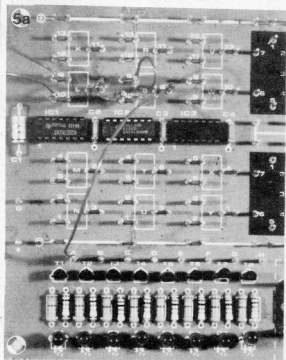
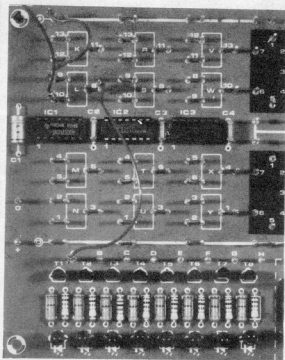
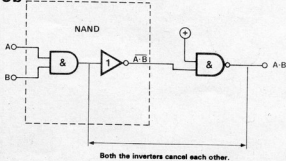

The NOR operation is also a combination of two basic operations, NOT and OR. The circuit diagram of the NOR gate can be constructed by a combination of an OR gate and an inverter.

### 6

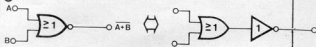

Also the truth table of the NOR gate can be derived from the truth table of an OR gate, by inverting the output column.

Table 2.

		OR	NOR
A	B	A + B	$\overline{A + B}$
0	0	0	1
0	1	1	0
1	0	1	0
1	1	1	0

This truth table also shows that, as in case of the NAND gate, NOR gate also behaves as an inverter when one of the input is tied to "0" or when both the inputs are tied together.

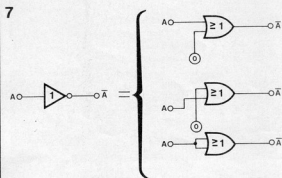

If an inverter obtained in this way is connected in front of a NOR gate, both the inverters cancel each other and what remains is an OR gate.

8b

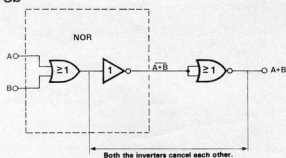

With the two gates introduced in this chapter, numerous interesting circuits can be constructed on the Digilex-Board.

9

ICs seen from top.

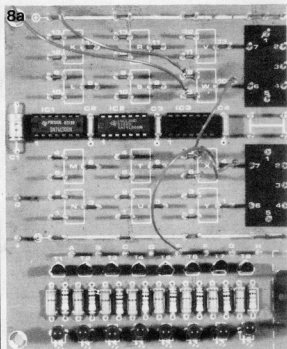
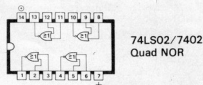
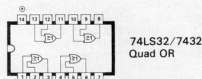
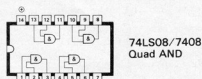
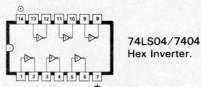
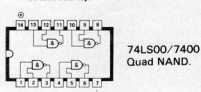

The input output in configurations of the NOR gate ICs differ from those of the NAND gate ICs. Therefore on the Digilex-Board, an extra socket is provided for IC 3 (74 LS 02 or 7402), which contains four NOR gates V, W, X and Y.



# Voltage

"What is Voltage? ..... the label on this new mixer says: Voltage 230 V."

"Well, Voltage is in a way the force of electricity. 230 V means 230 Volts. That is the force of Electricity available in the plug socket. Volt is the unit of measuring that force. The 230 V label on the mixer means that the mixer will work on a source of Electricity giving 230 Volts, i.e. the plug socket. The electricity from the plug socket is much stronger than the electricity from a torch cell."

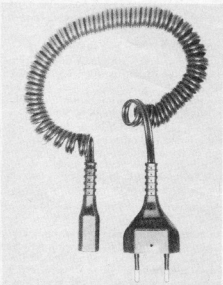

"Yes, that has only 1.5 V."

".....that is right! And the high Voltage lines, which conduct a very large amount of Electricity, have 220,000 V. This is written in short as 220 KV. (220 Kilo Volts—Kilo means one thousand).

"But we don't see the force of these high Voltage lines."

"No, no, these lines themselves have no force at all. The Electricity in these lines has the force, and it is but natural that we don't see this force. Same is the

case with the water pipe. The more is the pressure inside the water pipe, the more is the force of the water and the faster it sprays, when you turn on the tap. Even when the tap is closed, the water is under pressure and has the same force, but you don't see anything." "I see, then the 230 Volts are also in the plug socket, even when there is no plug in it."

# Frequency

".....What is the meaning of the wave here?"

"Which wave?"

"Here, on this mixer's name plate. After the Voltage: 230 V, they have shown this wave  $\sim$ . Now I know what 230 V means, but what about this wave here?" Does it mean 230 V but slightly undulating?"

"No, the wave means alternating voltage. It is not similar to the torch cell Voltage, which is called the direct Voltage. The torch cell has the plus pole on the top cap and the minus pole at the bottom. However, the 230 V plug socket does not have fixed plus and minus poles. The plus and minus poles in the plug socket continuously alternate between the right hole and the left hole with respect to each other. When plus pole is on the right hole, the minus pole is on the left hole. Then the plus pole is on the left hole and the minus pole is on the right hole. This is called alternating Voltage."

"This is repeatedly reversed!"

"Yes, but it is done very fast. The polarity is reversed after every one hundredth of a second. That means that the right hole of the socket becomes a plus pole 50 times per second with respect to the left hole and a minus pole 50 times per second. Same is the case with the left hole—it becomes a minus pole 50 times per second and plus pole 50 times per second with respect to the right hole. In the professional language these holes are called terminals."

"Now tell me, does this have something to do with this 50 Hz written next to this Wave?"

"Your guess is right! That is exactly what it is. Hz is the abbreviation for Hertz and means Cycles per second."

"Oh, now I know, why we can insert the plug in any direction. If the polarity is changing so rapidly, it is irrelevant how I insert the plug. Nevertheless, I find it somehow senseless."

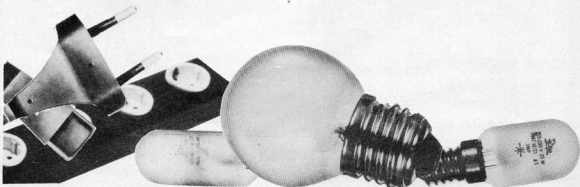

"Why senseless? That is rather practical!"

"Think of a railway engine, which pulls the train. Now just imagine, if the engine pulls the train once in one direction and once in the other, the train shall not move even an inch!"

"If you consider it that way, it would be really senseless. You must imagine this somewhat differently. Assume that the train has to visit three cities A B and C. There are now two routes. Either it travels from A-city to B-city to C-city to A-city to B-city to C-city and so on, or it travels from A-city to B-city to C-city to B-city to A-city and so on. On the first route it continuously moves forward ....."

"..... Like in case of direct Voltage."

"..... and on the second route, it must repeatedly change direction in A-city and C-city."

"..... just as the alternating Voltage changes polarity."

"Exactly!"

# Current

"What happens when we insert the plug into the plug socket?"

"The Electricity flows into the apparatus through the plug when we turn on the switch. This flowing Electricity is called current!"

"And where does this current remain?"

"The current flows\* from the plus pole through the apparatus, say a lamp, to the minus pole. The lamp is lighted by this flowing Electricity or current"

"So the plus pole always supplies fresh current and the minus pole takes up the consumed current."

"Well, there is nothing such as the consumed current. Imagine a brook, on the bank of which is a water mill. The flowing water in the brook gives its

energy to the wheel of the mill. In spite of this the water itself is not consumed."

"Oh yes, now I have understood this, but where does all this current go? Is there something like a 'Sea of Current'?"

"No, but there is a kind of 'Current Pump', which pumps the current again and again, so that it can flow 'down river' and turn the wheel of the mill once again."

"Current pump? can we really pump current?"

"By 'Current Pump' I mean the Power plant. The current flows from the lamp through the minus pole into the Power plant. The Power plant has a generator, which is something like a current pump. It is driven by a water turbine and conveys the current from the minus pole to the plus pole again, so that it can once again flow through the lamps and other apparatus."

"Can current always flow only in a circle?"

"Yes, that's right! And it is called a Circuit. If this circuit is interrupted at any position, with a switch for instance ....."

"..... then the current cannot flow any longer through the line, and the generator must be stopped."

"Actually yes, but as the generator is also operating many more lamps and other apparatus, your switching off the lamp does not affect its operation. However at night, when the total power consumption reduces, a few generators in the power plant are really switched off."

"Is there something for current just as Volts for the Voltage?"

"Yes the current is measured in Amperes and it is simply abbreviated with A. By the way, an Ampere is quite a bit of current. About half an Ampere flows through a 100 Watt bulb."

"Ampere, haven't I seen this on the fuses? 10A, 15A and so on?"

*\* In reality the current flows, or to be more accurate, the negative charges flow from minus pole to plus pole. But the scientists of the earlier days denoted the direction of current flow from plus pole to minus pole and this has remained so till today.*

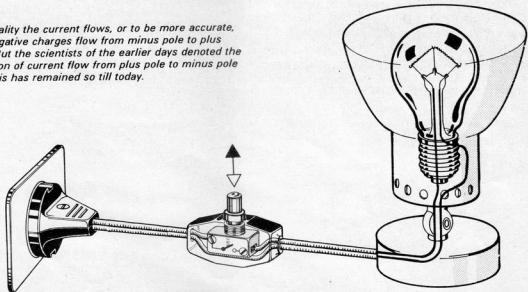

83638X-b

"Right! The fuse blows when the current in the wiring is more than 15 Amperes. This happens when there is a short circuit somewhere in the house. The fuse blows open and interrupts the circuit automatically."

"Do you remember what we said about the alternating Voltage polarities?"

"Yes, I remember. The polarity of the two plug socket connections reverses every one hundredth of a second"

"The same is true for alternating Current. It reverses direction of flow every one hundredth of a second."

"Quite clear! but I am thinking of something else. I think, we should not pay the next Electricity bill at all!"

"And why, if I may ask?"

"You have said yourself that the current is actually not consumed at all. It really flows back to the Power plant. So, if we do not consume any current, we need not pay for any Electricity consumption...."

"Ha Ha, that's a good joke!"

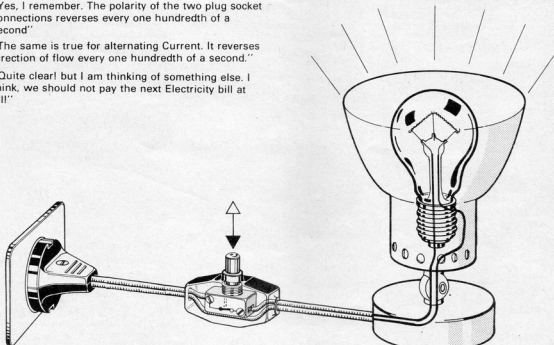

83638X - a

## Digilex and Selex PCBs

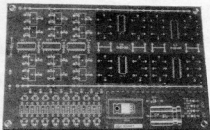

- Digilex and Selex PCBs will be available shortly.
- Details and Prices will be announced in our next issue.

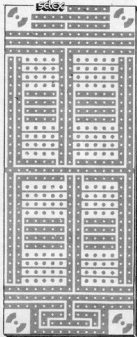

## 19 INCH SUBRACKS

Asavari Enterprises have marketed their new range of subracks which are manufactured as per the 19 inch rack standards. The units are available in kit form complete with screws etc. The available depths are 7" and 10" and the available heights are 2 to 6 units of 1.75" each. Variations from standard designs are also manufactured against specific order. The subracks are manufactured from aluminium and are anodised in white matt finish.

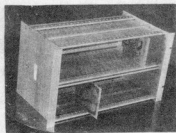

For further information, write to:

Asavari Enterprises,  
11-12, Sukanya Nivas,  
433, J.S. Road, Chirabazar,  
Bombay 400 002.

## SOLDERING IRON

SOLDRON have recently introduced a 50 Watt/230V soldering iron. This new model has features similar to the 25 Watt quick heating light weight soldering iron. Due to its high efficiency, the 50 Watt soldering iron can replace the conventional 65 Watt soldering iron and the resulting saving in electrical consumption is claimed to be about 20%. The iron comes with a 'Cool Grip' polypropylene handle. 5mm spade and 5mm chisel type slip on bits are available.



For further information, write to:

Bombay Insulated Cables & Wires Co.,  
74, Podar Chambers, S.A. Brelvi Road,  
Bombay 400 001.

## PLA RELAYS

PLA introduce relays type 'PC' and series 'M'. The relays type 'PC' are specially developed to withstand shock and vibration encountered in textile industry. These are used in the 'Stop Motions' for textile machines like draw frames, speed frames, combers, carding machines etc. The relays type 'PC' are available in various contact combinations and are mounted on octal sockets.

The series 'M' miniature relays are designed to absorb transit bumps thereby preventing any damage to the contact blades in transit. These are available in three versions—MCO (open type), MCC (enclosed type) and MPC (plugging in type). Various contact combinations are available.

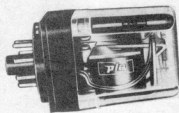

For further information, write to:

SAI Electronics,  
Thakore Estate, Kurla Kiroi Road,  
Vidyanagar (W), Bombay 400 086.

## INDICATING CONTROLLER

IRA's Digitherm-1000 MC series digital indicating temperature controllers are available with 1, 2 and 3 set points. Set points can be provided with or without dead bands, and can be used for ON/OFF control alarm control, pump control or star delta change over control. The dead band is programmable from the front panel. Three and half digit LED display is provided and has an accuracy of 0.5% and resolution of 0.1°C or 1°C depending on the full scale range. The instrument is provided with broken sensor alarm and trip circuits, built in calibration check facility, alarm acknowledgement switches, relay condition indicators and over range indicators. Optional facilities include parallel BCD outputs, time proportional ON/OFF control and digital printer. The controllers are claimed to be immune to noise.



For further information, write to:

Instrument Research Associates Pvt.  
Ltd.,  
P.O. No. 2304, No. 79/1-2,  
Magadi Road,  
Bangalore 560 023.

## PUSH BUTTON TELEPHONE

Kayjay Engineers have introduced a push button telephone KJ 100. The elegant, handy telephone instrument with soft touch keypad has 17 digit dialling facility. It also has a mute button for private conversation, ringer ON/OFF switch and last number redial facility. The instrument carries a six month guarantee.

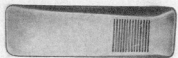

For further information, write to:

Kayjay Engineers,  
123, Mahatma Gandhi Road,  
Bombay 400 023.

## CONDUCTIVITY METER

Spectrum Services offer a new digital conductivity meter with features like automatic capacitance compensation, direct readout of cell constant on LED display and lock-nut facility. Conductivity measurement has five ranges. The instrument uses the latest ICs and is housed in an ABC casing. The conductivity meter finds application in chemical, pharmaceutical and analytical labs, food, agricultural and oil industries and in pollution monitoring organisations.

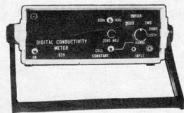

For further information, write to:

Spectrum Services  
Post Box No. 7623  
Malad (West), Bombay 400 064.

## ITALIAN KNOW-HOW

M/s. Fracarro of Italy, claimed to be the largest manufacturers of TV antennae in Europe, are willing to enter into technical collaboration with Indian manufacturers. The Antenna for receiving transmission directly from satellites is their specialisation.

For further information, write to:

Italian Technical Services,  
P.O. Box No. 3072,  
New Delhi 110 003.

## HAND HELD TACHOMETER

Beacon digital tachometer is a compact hand held tachometer with a range of 0 to 10000 RPM and accuracy of  $\pm 1$  rpm. It has 4 digit LED display with half inch digits. The memory stores the last reading which can be called back any time by pressing the memory button. The same instrument can be used to measure linear speeds upto 1000 Mts/Min with an accuracy of  $\pm 0.1$  Mts/Min. using an optional attachment. The instrument works on 6V DC, supplied by four pencil cells.



For further information, write to:

Beacon Industrial Electronics Pvt. Ltd.  
13-A, Shri Ram Industrial Estate,  
Katrak Road, Wadala, Bombay 400 031.

## REED RELAY

PLA series DRM miniature reed relays are suitable for PCB mounting on 2.54 mm grid. The relays are LCSC approved and are available with 5, 6, 12 and 24 V DC coils. Various contact combinations are offered. These relays are capable of switching 10 VA at 0.5 Amp. Isolation is claimed to be excellent.

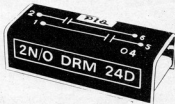

For further information, write to:

SAI Electronics  
Thakore Estate, Kurla Kiro Road,  
Vidyavihar (West), Bombay 400 086.

## SINGLE BOARD MICRO

IMC-65 is a single board micro computer offered by Control Dynamics Systems. The unit is offered with 54 key-deachable keyboard, alphanumeric fluorescent display, two audio cassette interfaces, battery backed CMOS RAMs, RS 232 C interface, 48 digital I/O lines, 6 programmable timers/counters, 3 bi-directional data ports, 6 edge triggered programmable inputs, 7 channel 8 Bit A/D converter and switch selectable program development languages. Many additional options are available.

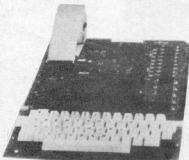

For further information, write to:

Control Dynamics Systems  
2412, Sidikola Pole,  
Near Kalupur Gate,  
Ahmedabad 380 001.

## UNIVERSAL VICE

Elmatronik Sales Corporation offer a new universal vice which can be tilted in any direction and locked in that position. A ball and socket joint facilitates rotation in all directions. Side swivelling is possible upto  $90^\circ$ . The vice can be easily clamped on a workbench and weighs only 1.5 Kg.

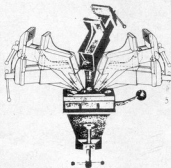

For further information, write to:

Elmatronik Sales Corporation  
Gandhi Peak, 144 Bharathi Salai,  
Royapettah, Madras 600 014.

## HIGH VOLTAGE CAPACITORS

CSI Capacitors, U.S.A. offer for the first time in India, High Voltage Capacitors used for detonators and other firing circuits. The range covers capacitors from 0.1 to 5 microfarads. The capacitors use extended foils and polyester dielectric. RMS current rating is 3 A with repetitive peak current rating ranging from 100 A to 30 KA. Voltage ratings upto 9KVDC are available. The inductance and resistance is claimed to be very low.



For further information, write to:

Toshni Tek International  
267, Kilpauk Garden Road,  
Madras 600 010

## SERVO VOLTAGE STABILISERS

Jayant Electric and Radio Corpn. introduce Servo Voltage Stabilisers. The stabiliser senses the AC voltage fluctuations and corrects them within a tolerance of  $\pm 1\%$ . The solid state control circuit has higher and lower limit cut off with visual indications. The stabiliser provides an output voltage of 230 V AC  $\pm 1\%$ , single phase, 50 Hz. It accepts an input voltage of 160 to 260 V AC. Capacity upto 10 KVA is available. The operation is unaffected by load power factor.

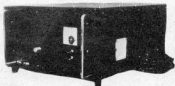

For further information, write to:

Jayant Electric and Radio Corpn.  
5 B, Naigaum Cross Road,  
Wadala, Bombay 400 031.

## DIGITAL THERMOMETER

Century Instruments have developed a mini digital thermometer with LCD display. It has a range of 0 to  $1200^\circ\text{C}$  with  $1^\circ\text{C}$  resolution. Input is compatible with thermocouple, RTD and semiconductor sensors. In case of Thermocouples, automatic cold junction compensation is provided upto  $50^\circ\text{C}$ . The thermometer works on 9 V miniature battery.

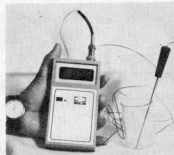

For further information, write to:

Century Instruments Pvt. Ltd.,  
SCO 289, 1st floor, Sector 35-D,  
Chandigarh 160 036.

# UPTRON, Capacitors

DISTRIBUTOR

# apex

**ELECTRONICS (BOMBAY) PVT. LTD.**

GANESH NIWAS, 11, TARATEMPLE  
LANE, BOMBAY-400 007

TEL: 363599/356529

RESI: 624931

TELEX: 011-6688 VASU-IN

# SATO

(KI-18)  
(KI-17)  
(KI-16)  
(KI-15)  
(KI-22)  
(KI-21)  
(KI-20)  
(KI-19)  
(KI-23)  
(KI-22)  
(KI-21)  
(KI-20)  
(KI-19)  
(KI-18)  
(KI-17)  
(KI-16)  
(KI-15)  
(KI-14)  
(KI-13)  
(KI-12)  
(KI-11)  
(KI-10)  
(KI-9)  
(KI-8)  
(KI-7)  
(KI-6)  
(KI-5)  
(KI-4)  
(KI-3)  
(KI-2)  
(KI-1)

**KHANNA INDUSTRIES (Pvt.) Ltd.**  
B-288, 288 JANTA COLONY,  
NEW DELHI - 110027

Distributors: **G. S. Electronics**  
2 Moreasia Road  
Lajpat nagar  
Delhi-110 006

## LOW COST HIGH QUALITY Relays-a-Plenty

 Series 108, 111, 112, 113, 117 30 Amps, 25 Amps, 15 Amps	 Series 106 10 Amps	 Series 106, 110, 111, 112, 113, 117 25 Amps, 30 Amps, 30 Amps, 30 Amps, 30 Amps	 Series 134 to 136 15 Amps, 25 Amps, 30 Amps	 Series 103 5 Amps
 Series 104, 105, 106, 107, 108, 109, 110, 111, 112, 113, 114, 115, 116, 117, 118, 119, 120, 121, 122, 123, 124, 125, 126, 127, 128, 129, 130, 131, 132, 133, 134, 135, 136, 137, 138, 139, 140, 141, 142, 143, 144, 145, 146, 147, 148, 149, 150, 151, 152, 153, 154, 155, 156, 157, 158, 159, 160, 161, 162, 163, 164, 165, 166, 167, 168, 169, 170, 171, 172, 173, 174, 175, 176, 177, 178, 179, 180, 181, 182, 183, 184, 185, 186, 187, 188, 189, 190, 191, 192, 193, 194, 195, 196, 197, 198, 199, 200	 Series 107 20 Amps	 Series 106, 110, 111, 112, 113, 117 25 Amps, 30 Amps, 30 Amps	 Series 101 5 Amps	 Series 102 5 Amps
 Series 127 25 Amps	 Series 118 to 124 0.5 Amps to 5 Amps	 Series 106, 110, 111, 112, 113, 117 25 Amps, 30 Amps, 30 Amps	 Series 101 5 Amps	 Series 102 5 Amps
 Series 127 25 Amps	 Series 118 to 124 0.5 Amps to 5 Amps	 Series 106, 110, 111, 112, 113, 117 25 Amps, 30 Amps, 30 Amps	 Series 101 5 Amps	 Series 102 5 Amps
 Series 102 5 Amps	 Series 104 5 Amps	 Series 106, 110, 111, 112, 113, 117 25 Amps, 30 Amps, 30 Amps	 Series 101 5 Amps	 Series 102 5 Amps

**Eagleman**  
*Industries*

3/19-A, Kirti Nagar,  
Industrial Area,  
New Delhi-110015  
Phone: 535770  
Grams: EAGLENT

Small of large quantity orders receive the same careful attention by the people that have the "Know How".  
Eagleman engineers become part of your design group in selecting the correct type of relay to meet all requirements.

Relay with its many years of Engineering and Production experience builds relays to all quality levels. Relays from the most exacting to the simplest in operating "specifications" are readily available at Eagleman.

Relay Series 101: 5 Amps  
Relay Series 102: 5 Amps  
Relay Series 103: 5 Amps  
Relay Series 104: 5 Amps  
Relay Series 105: 5 Amps  
Relay Series 106: 10 Amps  
Relay Series 107: 20 Amps  
Relay Series 108: 30 Amps  
Relay Series 109: 30 Amps  
Relay Series 110: 30 Amps  
Relay Series 111: 30 Amps  
Relay Series 112: 30 Amps  
Relay Series 113: 30 Amps  
Relay Series 114: 30 Amps  
Relay Series 115: 30 Amps  
Relay Series 116: 30 Amps  
Relay Series 117: 30 Amps  
Relay Series 118: 0.5 Amps  
Relay Series 119: 1 Amps  
Relay Series 120: 2 Amps  
Relay Series 121: 3 Amps  
Relay Series 122: 5 Amps  
Relay Series 123: 10 Amps  
Relay Series 124: 20 Amps  
Relay Series 125: 30 Amps  
Relay Series 126: 30 Amps  
Relay Series 127: 25 Amps  
Relay Series 128: 25 Amps  
Relay Series 129: 25 Amps  
Relay Series 130: 25 Amps  
Relay Series 131: 25 Amps  
Relay Series 132: 25 Amps  
Relay Series 133: 25 Amps  
Relay Series 134: 25 Amps  
Relay Series 135: 25 Amps  
Relay Series 136: 25 Amps  
Relay Series 137: 25 Amps  
Relay Series 138: 25 Amps  
Relay Series 139: 25 Amps  
Relay Series 140: 25 Amps  
Relay Series 141: 25 Amps  
Relay Series 142: 25 Amps  
Relay Series 143: 25 Amps  
Relay Series 144: 25 Amps  
Relay Series 145: 25 Amps  
Relay Series 146: 25 Amps  
Relay Series 147: 25 Amps  
Relay Series 148: 25 Amps  
Relay Series 149: 25 Amps  
Relay Series 150: 25 Amps  
Relay Series 151: 25 Amps  
Relay Series 152: 25 Amps  
Relay Series 153: 25 Amps  
Relay Series 154: 25 Amps  
Relay Series 155: 25 Amps  
Relay Series 156: 25 Amps  
Relay Series 157: 25 Amps  
Relay Series 158: 25 Amps  
Relay Series 159: 25 Amps  
Relay Series 160: 25 Amps  
Relay Series 161: 25 Amps  
Relay Series 162: 25 Amps  
Relay Series 163: 25 Amps  
Relay Series 164: 25 Amps  
Relay Series 165: 25 Amps  
Relay Series 166: 25 Amps  
Relay Series 167: 25 Amps  
Relay Series 168: 25 Amps  
Relay Series 169: 25 Amps  
Relay Series 170: 25 Amps  
Relay Series 171: 25 Amps  
Relay Series 172: 25 Amps  
Relay Series 173: 25 Amps  
Relay Series 174: 25 Amps  
Relay Series 175: 25 Amps  
Relay Series 176: 25 Amps  
Relay Series 177: 25 Amps  
Relay Series 178: 25 Amps  
Relay Series 179: 25 Amps  
Relay Series 180: 25 Amps  
Relay Series 181: 25 Amps  
Relay Series 182: 25 Amps  
Relay Series 183: 25 Amps  
Relay Series 184: 25 Amps  
Relay Series 185: 25 Amps  
Relay Series 186: 25 Amps  
Relay Series 187: 25 Amps  
Relay Series 188: 25 Amps  
Relay Series 189: 25 Amps  
Relay Series 190: 25 Amps  
Relay Series 191: 25 Amps  
Relay Series 192: 25 Amps  
Relay Series 193: 25 Amps  
Relay Series 194: 25 Amps  
Relay Series 195: 25 Amps  
Relay Series 196: 25 Amps  
Relay Series 197: 25 Amps  
Relay Series 198: 25 Amps  
Relay Series 199: 25 Amps  
Relay Series 200: 25 Amps

# COMTECH

## PANEL-MOUNTING INSTRUMENT CASE TYPE T-96

PLAIN - T-96-01

WITH INSTRUMENT CLAMP T-96-02

WITH CLAMP + TAG BLOCK T-96-03

- DIN Std.
- Size: 96 x 96 x 150 mm
- 3 Models
- Black & Beige Colour
- Moulded in ABS Plastics.

For  
 • Counters  
 • Temperature Indicator

For more information, contact:  
**COMPONENT TECHNIQUE**  
 8, Orion Apartment, 29/A Lallubhai Park Road,  
 Andheri (West) Bombay-400 058 Tel: Sales: 4224066

Positive arts

# El-Ci-Ar<sup>®</sup>

# resistors

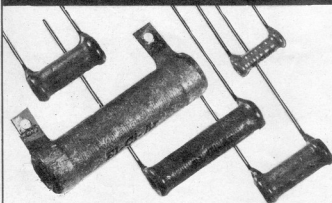

### Wire Wound Resistors— Varnish/Silicone Coated:

For Electronic instruments, Professional equipments, Power supplies, Audio amplifiers, Cassette decks, Radios, TVs and Fan regulators.

### Non Inductive Power Resistors:

For Thyristor drives, Control panels, Induction heating furnaces and for test loading of Audio equipments.

### Adjustable Resistors/Precision Wire Wound Resistors:

Available against specific requirement.

Manufactured by:

**Neutroniks Pvt. Ltd.**

68, Hadapsar Industrial Estate, Pune 411 013.  
Phone: 70428, Gram: ELCIAR

85, Arcadia, 195 Nariman Road, Nariman Point,  
Bombay - 400 021 Phone - 221359.

Sonika

# SOLE S



- Works effectively on single/double-sided PC Boards.
- Powerful vacuum suction.
- Low recoil action.
- Dependable performance.
- Assured results.
- Every stroke self cleaning.
- Replacable tip.

## LARGEST SELLING

## DESOLDERING PUMP

Internationally  
Accepted

With  
Unmatched  
Performance

**INDUSTRIAL RADIO HOUSE**

12, Gandhi Bhavan, First Floor, Chunan Lane,  
Off. Dr. Bhadkamkar Marg, Mumbai - 400 007

Phone : 38 21 04

## MICRO PROFESSOR

- MPF-1 B Z-80 Based Microprofessor Training Kit with various options.
- MPF-II A new "Apple Compatible" 6502 based personal computer.
- 64 K memory, Colour graphics, Audio Cassette, TV & Printer Interface. Optional Floppy drive interface & full size keyboard.

## BRISK

394, Lamington Road,  
BOMBAY-400 004.

Tel:  
35 40 16  
35 85 37

## CONDITIONS OF ACCEPTANCE OF CLASSIFIED ADVERTISEMENTS

1) Advertisements are accepted subject to the conditions appearing on our current rate card and on the express understanding that the Advertiser warrants that the advertisement does not contravene any trade act in force in the country.

2) The Publishers reserve the right to refuse or withdraw any advertisement.

3) Although every care is taken, the Publishers shall not be liable for clerical or printer's errors or their consequences.

4) The Advertiser's full name and address must accompany each advertisement submitted.

The prepaid rate for classified advertisement is Rs. 2.00 per word (minimum 24 words). Semi Display panels of 3 cms by 1 column. Rs. 150.00 per panel. All cheques, money orders, etc. to be made payable to Elektor Electronics Pvt. Ltd. Advertisements, together with remittance, should be sent to The Classified Advertisement Manager. For outstation cheques please add Rs. 2.50

## SELLING OF THE INVENTORSHIP &amp; MANUFACTURING RIGHTS

7 Models of world's first new invention, Current operated shock Alarm/Cut-off-Device. This device provides that shock protection on 1/2mA and even when it is broken or burnt. It has other 4 specialities which are not provided in other existing devices of the world and on which there is 99% possibility of the National Award.

Contact:  
NEW INDIA RESEARCH LABORATORY,  
1253, Uprenjunj, Dixitpura,  
JABALPUR-482002 (M.P.)

Transistor-Radio-Television-Postal Tuition. Admission Fee Rs. 5/-. (Stipend Rs. 30/- arranged for deserved candidates. Contact: Renuka Electronics Institute, 18, Ranganathan Street, Nehrunagar, Chromepet, Madras - 600 044.

APEX .....	6.66
BALAJI .....	6.68
BRISK .....	6.72
COMPONENT TECHNIQUE .....	6.66
CONNECTRONICS .....	6.06
COSMIC .....	6.76
DANNIES ELECTRONICS .....	6.68
DYNALOG .....	6.05
EAGLEMAN ENTERPRISES .....	6.66
ELCIAR .....	6.72
ELTEK BOOKS-N-KITS .....	6.73
GRAPHICA DISPLAY .....	6.73
IEAP .....	6.06
ION ELECTRICALS .....	6.04
INDUSTRIAL RADIO HOUSE .....	6.72
IZUMIYA .....	6.70
JETKING .....	6.70
KAYTEE ENTERPRISE .....	6.06
KELTRON .....	6.07
KOTHARI ELECTRONICS .....	6.11
LUXCO .....	6.71
MOTWANE .....	6.67
OM LILA'S .....	6.73
PADMA .....	6.04
SIEMENS .....	6.08 6.09
SATO .....	6.66
TEXONIK .....	6.04
TESTICA .....	6.68
VASAVI .....	6.73
VISHA .....	6.75
ZODIAC .....	6.70

## missing link

## Reading in bed limiter

(May 1985, page 5-53)

This article is incomplete in the above issue. The complete article is featured in this issue (June 1985)

## the first cuckoo in spring...

(May 1985, page 5-35)

The operational amplifier in the ICI position should be a type TL084 and not LM324 as stated.



**3324** **COSMIC**  
**COLOURVISION**

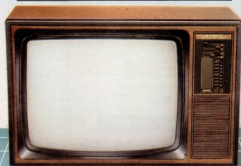

**COSMIC** COLOURVISION 3324  
offers colour with style.  
with it's built in electronic tuner

Three decades in the field of electronics has  
helped Cosmic in creating an Audio-Visual marvel

- 51 cms. The carefully manufactured multifunction unit
- High intensity picture tube offers vibrant colours  
with perfect sound.
  - 8 mode channel selector.
- Matches any Video system-UHF or VHF

**Off with flying colours**